



12x4 GardenSaver

Sliding Doors - Metal Roof - FJ Siding

Assembly Manual

Version #2.7
Mar 31, 2022

Stock Code:
GS124-SLIDER-METAL-FJ

Thank you for purchasing a 12x4 GardenSaver Shed with Sliding Double Doors. Please take the time to identify all the parts prior to assembly.

Safety Points and Other Considerations

Our products are built for use based on proper installation on level ground and normal residential use. Please follow the instruction manual when building your shed and retain the manual for future maintenance purposes.

Customers are responsible for ensuring a solid, level, well-draining site for construction.

Please check with your local municipal or county by-laws before ordering this product to confirm it complies with building codes.



- Snow load ratings vary by geographical location. If heavy or wet snowfall occurs, it is advisable to sweep snow off roof frequently.
- If the product is elevated, any structural and building code requirements are solely the customer's responsibility, and should be abided by.
- In areas with high or gusty wind conditions, it is advisable to install the structure securely to the ground.
- Have a regular maintenance plan to ensure screws, doors, windows and parts are tightly affixed.

Customer agrees to hold Outdoor Living Today and any Authorized Dealers free of any liability for improper installation, maintenance and repair.

In the event of a missing or broken piece, call the Outdoor Living Today Customer Support Line @ 1-888-658-1658 within 30 days of the delivery of your purchase. It is our commitment to you to courier replacement parts, free of charge, within 10 business days of this notification. Replacement parts will not be provided free of charge after the 30 day grace period.

All structures purchased from Outdoor Living Today are covered for a period of one year for defects in manufacturing and workmanship. Costs incurred for customer installations are not included.

Failure to use supplied parts included in this kit could result in poor product performance and may void your warranty. Please contact Outdoor Living Today's Customer Toll Free Line if you plan to deviate from our written instructions.

What to do before my Shed arrives?



- Become familiar with this assembly manual and determine if you can complete the project yourself or will require a professional contractor.



- One helper is recommended to assist in constructing your shed. It generally takes two people over two days to assemble a shed. If you're hiring a contractor, their rate should be in line with that duration of work.



- Clear the construction area and ensure a clear pathway for delivery when the freight company arrives. Remove all debris: roots, grass, rocks, etc.



- Excavate the site. Contact your local utilities company to ensure there are no gas or electric lines buried in the area before digging.

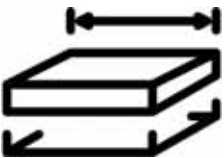

- Decide on the type of foundation you will be using:
 - Concrete slab, or
 - 4-6 inches of crushed gravel with paver stones or 4x4 stringers.

You can find the footprint for your shed on Page 3 of your Assembly Manual.



- If doing the assembly yourself, have all the necessary tools ready to go and in working condition. A list of required tools can be found after the parts list.

Foundation Types for 12x4 Garden Shed

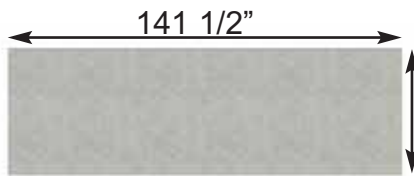

Concrete Foundation

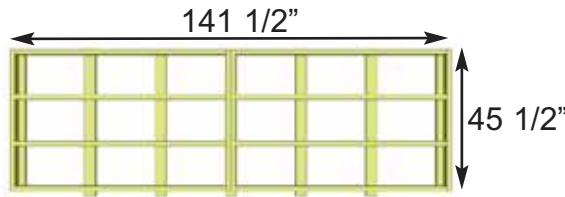

Floor Frame

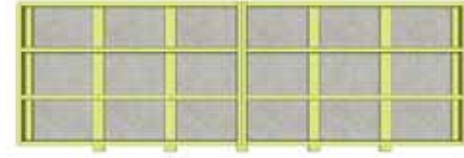

Completed Foundation

Concrete Slab Foundation:

- Slab must be at least the same size as assembled floor frame (45 1/2" x 141 1/2") or larger.
- 6" Deep foundation.
- 0.9 Cubic Yards of concrete required.
- A concrete slab will have the longest durability out of your foundation options.

Once level, a concrete slab is the easiest surface to build on.

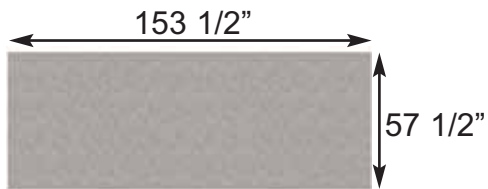

Gravel Foundation



3 - 4"x4"x144"

Gravel Foundation with treated stringers

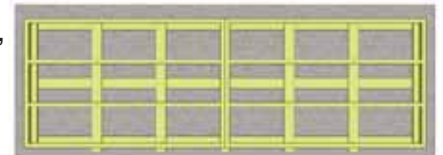

Completed Foundation

Gravel with 4x4 Pressure Treated Stringers:

- Excavate at least 6" deep, and 6" wider than floor frame on each side.
- 1.2 Cubic Yards of gravel required, approximately 11 wheelbarrows.
- 3 - 4x4 Pressure Treated Stringers 12' long required.
- Evenly spaced, with one at each end of floor frame.

Saves money on materials, easy to level and work with.

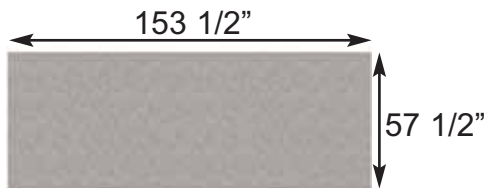

Gravel Foundation

21 Patio Stones



Gravel Foundation with Patio Pavers

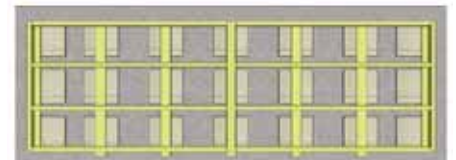

Completed Foundation

Gravel with Patio Paver Stones:

- Excavate at least 6" deep, and 6" wider than floor frame on each side.
- 1.2 Cubic Yards of gravel required, approximately 11 wheelbarrows.
- 21 patio pavers (8" x 8" or larger).
- Center patio paver stones underneath floor runners and underneath seams in floor joists.

Patio paver stones are widely available from most landscape stores.

Thank you for purchasing our 12x4 Slider Lean-To Storage Shed.
Please take the time to identify all the parts prior to assembly.

1. Floor Section	Parts List - Pages 4 and 5	Steps ↓
Floors ----- 1A: 2 - 45 1/2" x 70 3/4" - Floor Frames 1B: 4 - 1 1/2" x 3 1/2" x 67 3/4" - Floor Joists 1C: 2 - 1 1/2" x 3 1/2" x 45 1/2" - Floor Runners - Short 1CC: 5 - 1 1/2" x 3 1/2" x 47 1/2" - Floor Runners - Long 1D: 2 - 5/8" x 45 3/8" x 70 5/8" - Plywood Floor		1-6
2. Wall Section Main Wall Panels ----- 2AA: 5 - 45 1/2" x 75" - Side/Rear Wall Panels 2AB: 5 - 1 5/8" x 2 1/2" x 45 1/2" - Bottom Wall Plates - Side/Rear Walls 2BA: 2 - 35" x 73" - Front Wall Panels 2BB: 2 - 1 5/8" x 2 1/2" x 35" - Bottom Wall Plates - Front Walls Door Headers ----- 2C: 2 - 2" x 3 1/2" x 26 1/4" - Door Headers - Short 2D: 1 - 2" x 3 1/2" x 84" - Door Header - Long (88" Aluminum Strip Attached) 2E: 1 - 1 1/2" x 3" x 66 1/2" - Interior Door Header Extender Walls ----- 2F: 2 - Top Triangular Siding Pc for Angle Wall Extenders 2G: 2 - 45 1/4" - Angle Wall Extenders - Left/Right 2H: 3 - 9" x 45 1/2" - Wall Extenders 2I: 3 - 1 1/2" x 2 1/2" x 42 3/8" - Wall Extender Cleats Wall Cleats ----- 2J: 1 - 3/4" x 3 1/2" x 84" - Horizontal Wall Cleat - Long 2K: 2 - 3/4" x 3 1/2" x 26 1/4" - Horizontal Wall Cleats - Short		Steps ↓ 7-13 14-15, 23 16-21 22
Rafters ----- 3A: 9 - 1 1/2" x 2 1/2" x 54" - Rafters 3B: 4 - 1/2" x 3 1/2" x 48" - Front & Rear Soffits - Left/Right 3C: 2 - 1/2" x 3 1/2" x 45 1/2" - Front & Rear Soffit - Center Roofs ----- 3D: 4 - 3/4" x 1 1/2" x 21 5/8" - Batten Spacers 3G: 6 - 3/4" x 3 1/2" 50" - Roof Battens Outside 3H: 3 - 3/4" x 3 1/2" x 45 1/2" - Roof Battens Center 3J: 2 - 3/4" x 3/4" x 51" - Facia Nailing Strips 3K: 5 - Metal Roof Panels - 39" x 58 1/2"		Steps ↓ 25-29 30-44
Note: There are no parts 3F or 3I		

Continued on next page

Advice: Wood has a tendency to split when screwing near the ends of a board. To prevent splitting, it is always recommended to pre-drill pilot holes before screwing into these areas.



4. Trim & Miscellaneous Section	Steps ↓
Bottom Skirting & Top Wall Trim ----- 4A: 5 - 1/2" x 4 1/2" x 45 1/4" - Side/Rear Bottom Skirting (FJ Bevel Siding) 4B: 3 - 1/2" x 4" x 45 1/4" - Front Bottom Skirting 4BB: 3 - 3/4" x 1 1/2" x 45 1/4" - Top Wall Trims (FJ Bevel)	45-48
Filler Trim ----- 4C: 4 - 1/2" x 2 1/2" x 42" - Front Corner Filler Trims 4D: 4 - 3/4" x 2 1/2" x 38" - Rear Corner Filler Trims	49-50
Door System ----- 4E: 2 - Aluminum Door Tracks (with brackets attached) 4F: 2 - 36" x 73" - Sliding Doors 4G: 2 - 1 1/2" x 1 1/2" x 61 1/8" - Lower Door Track 4HA: 3 - 3/4" x 3" x 44 1/4" - Lower Door Track Cover 4IA: 3 - 1 1/2" x 2" x 3 1/2" - Sliding Door Track Stops 4J: 1 - 3/4" x 3 1/2" x 71 1/2" - Interior Door Flange 4KA: 2 - 1 1/2" x 3 1/2" x 66 1/2" - Track Overlay - Top 4KB: 2 - 3/4" x 5 1/2" x 67" - Track Overlay - Front 4KC: 2 - 1/2" x 3 1/2" x 5 1/2" - Track Overlay - Ends 4KD: 3 - 1/2" x 4 1/4" x 44 1/4" - Track Overlay - Sill (Bevel)	51-59
Outer Wall Trim ----- 4L: 2 - 1/2" x 5 1/2" x 88 3/4" - Front Corner Trims 4M: 2 - 1/2" x 2 1/2" x 88 3/4" - Side Front Corner Trims 4N: 2 - 1/2" x 5 1/2" x 78 1/2" - Rear Corner Trims 4O: 2 - 1/2" x 2 1/2" x 80" - Side Rear Corner Trims 4P: 2 - 1/2" x 2 1/2" x 78 1/2" - Rear Middle Trims 4Q: 2 - 1/2" x 2 1/2" x 7 1/2" - Front Middle Trims	60-63
Facia ----- 4R: 2 - 1/2" x 5 1/2" x 54 1/8" - Side Facia (Angle Cut Ends) 4S: 4 - 1/2" x 5 1/2" x 50 1/2" - Front and Rear Facia - Left/Right 4T: 2 - 1/2" x 5 1/2" x 45 1/2" - Front and Rear Facia - Center 4U: 3 - Trim Detail Plates (5 1/2" high)	64-68
Front Metal Drip Caps ----- 4V: 3 - 6" x 60" angled - Front Metal Drip Caps	69
Windows ----- 4W: 2 - Window Inserts 18 1/4"w x 23"h 4X: 2 - Window Trim Kits 1 - Top pc - 24 1/16" Length - Angle Cut Ends 3 - Side/Bottom pcs - 23" Length	70-72
Miscellaneous 4Y: 1 - 45 1/4" - Extra Piece of Bevel Wall Siding - Use if side/rear wall panel siding is damaged or to shim floor or door. 4Z: 1 - 36" - Extra Piece of Lap Siding - Use if front wall panel siding is damaged Foam Enclosures - Several Strips (Step 43)	

Note: All Trim, Facia, and Bottom Skirting pieces will be positioned rough face out when installed.

12X4 GardenSaver Shed with Sliding Double Doors and Metal Roof HARDWARE PACKAGE

BR1 - Square Drive Bit  x 2

BT2 - Torx Drive Bit  x 1

N1 - 1 1/2" Finishing Nails  x 330

ST1 - 1 1/2" Torx Screws  x 12

S5 - 4" Screws  x 8

S4 - 3" Screws  x 41

S1 - 2 1/2" Screws  x 229

S2 - 1 1/4" Screws  x 205

SB1 - 3/4" Screws  x 18
Black Headed

Nut Driver 
1/4" Nut Drivers

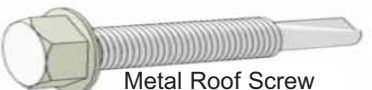
1/4"x 2" long  x 17
Metal Roof Screw

 Y2 - 90° Metal Bracket (Roof) x 4

 Silicon Caulking (1)

 Y35 - Roller Assembly x 4

 Y3 - Black Handle x 2

 Y11 - Black Hasp x 1

 Y38 - Metal Roof Hanger x 5

Tools Required (Not Provided)

 Utility Knife

 Pliers

 Hammer

 Screw Gun/Drill

 Tape Measure

 Level

 Wood Clamp

 Ladder

 1/8" Drill Bit

Safety Equipment Required

(Not Provided)

 Safety Glasses

 Work Gloves

Before/During Assembly:

- 1.) Paint each face and edge of your plywood floor with a latex exterior paint.
- 2.) Caulk wall seams if gaps appear.
- 3.) Caulk around window framing.
- 4.) Caulk perimeter between floor plywood and bottom wall plate.
- 5.) Caulk channels in lap siding at the top of your door above the trim, just a drop in each channel.
- 6.) Caulk edge of door threshold (if applicable)
- 7.) Optional: Install a Sill Gasket between floor runners and foundation.
- 8.) Optional: Install an 8" strip of roofing paper below Cedar Ridge Caps for Cedar Roof Sheds.

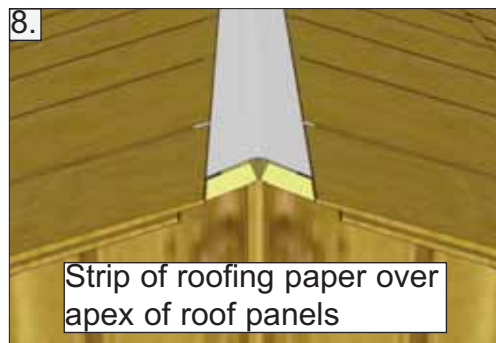
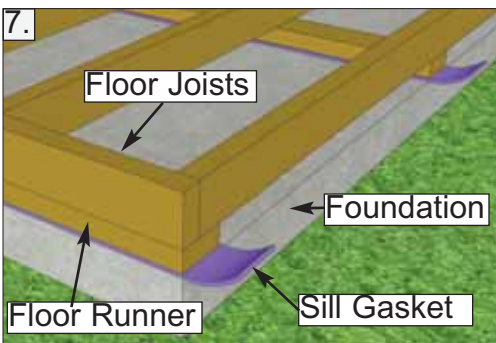
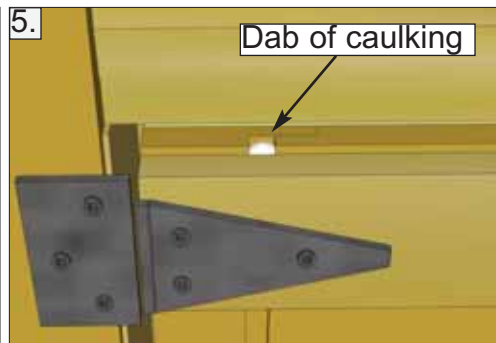
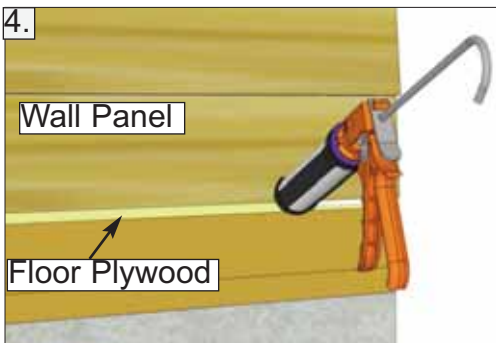
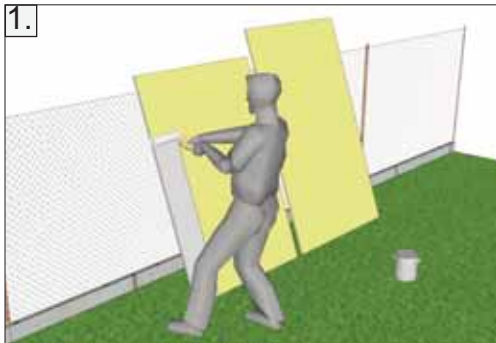

Routine Maintenance:

- Routinely check all fasteners are tight (ex. Door Hinges, Nails)
- Brush off dirt from walls.
- Brush off snow from roof regularly.
- Routinely remove needles and leaves from roof.

Painting/Staining

- Your cedar shed, if left untreated, will weather to a silvery grey colour.
- Painting or staining your structure is highly recommended and will prolong the life of your shed.
- You do not need to wait to paint or stain your shed, the wood in your kit has been dried and can be stained or painted immediately.
- Consult your local paint store for the best paint or stain for cedar.
- Optional: stain the inside of your shed. (Note: this will remove the fresh cedar smell.)

1. Floor Section

Exploded view of all parts necessary to complete Floor Section. Identify all parts prior to starting.
 Note: Floor Footprint is 141 1/2" wide x 45 1/2" deep.

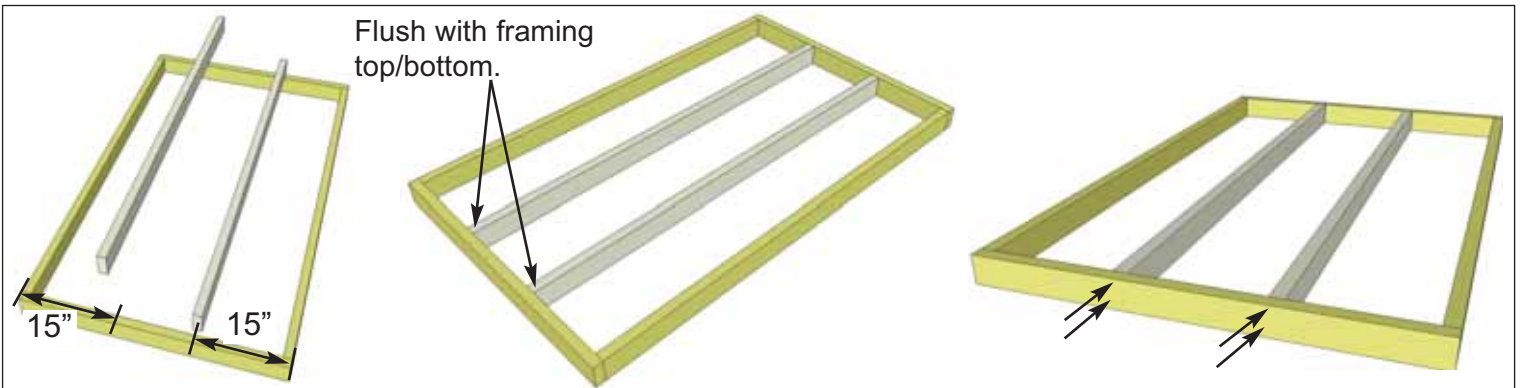
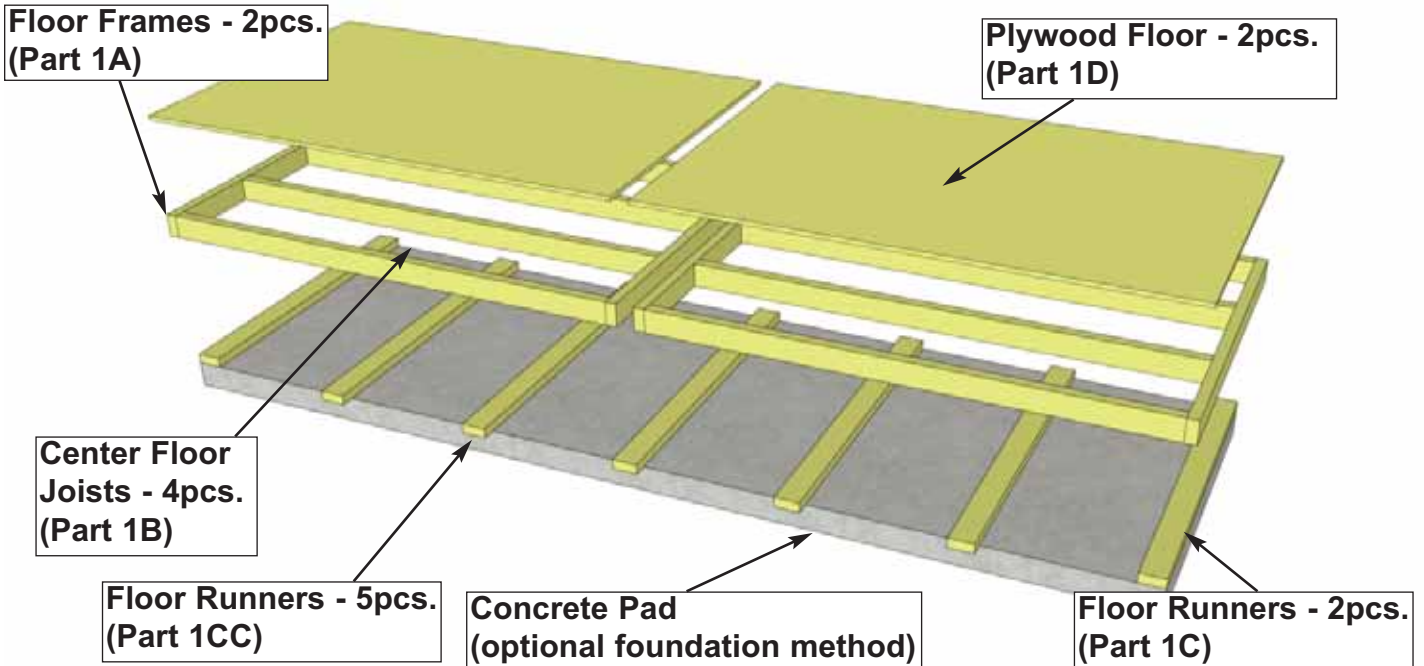

1. Lay out **1A - Floor Frame** and two **1B - Floor Joists** as illustrated above. Position the center of each Joist 15" from the outer edge of Floor Frame. When correctly positioned, attach each Joist with **4 - 2 1/2" Screws** (2 per end). **You can find the Square Drive Screw Bit in the Hardware Kit Bag.** Complete remaining Floor Frame the same.

<u>Parts</u>	
1A - Floor Joist Frames (45 1/2" x 70 3/4") x 2	
1B - Floor Joists (1 1/2" x 3 1/2" x 67 3/4") x 4	
<u>Hardware</u>	
S1 - 2 1/2" Screws x 16 total	

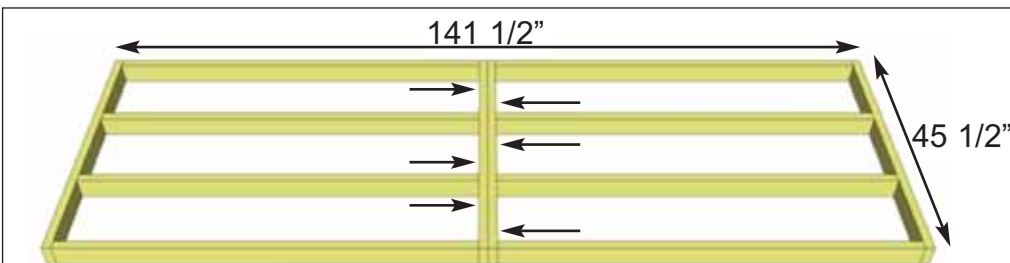

You can find BR1 - Square Drive Bit for the screws in with the Hardware Kit Bag.

2. Lay out both complete floor joist frames as illustrated. The footprint for the floor when attached together will be 141 1/2" wide x 45 1/2" deep. Attach frames together with **6 - 2 1/2" Screws**.

<u>Hardware</u>	
S1 - 2 1/2" Screws x 6 total	

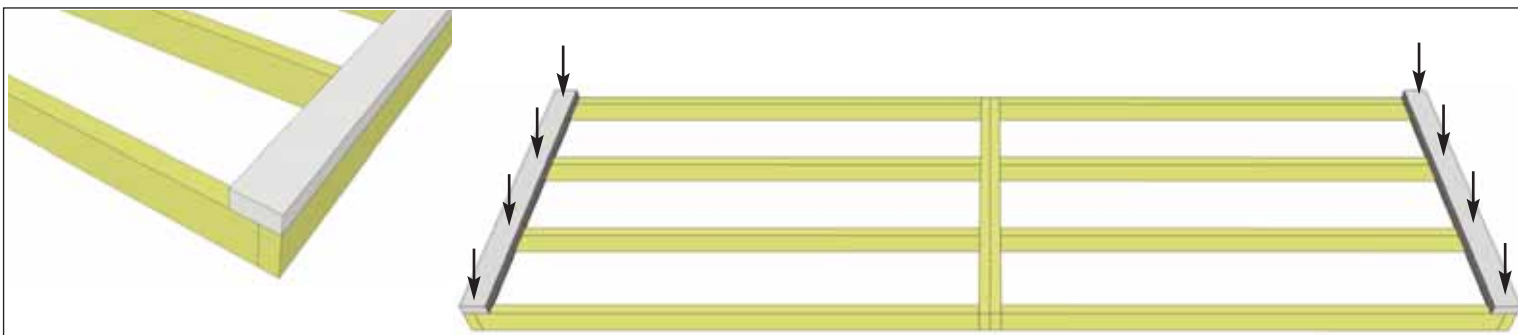

3. Position **1C - Floor Runners - Short** on each side of the completed floor frame. Runners should be flush with corners but not overhanging. Attach with **4 - 2 1/2" Screws** per Runner.

Parts
1C - Floor Runners - Short
 (1 1/2" x 3 1/2" x 45 1/2") x 2

Hardware
S1 - 2 1/2" Screws
 x 8 total

Floor Runners flush with Floor Frame on back.

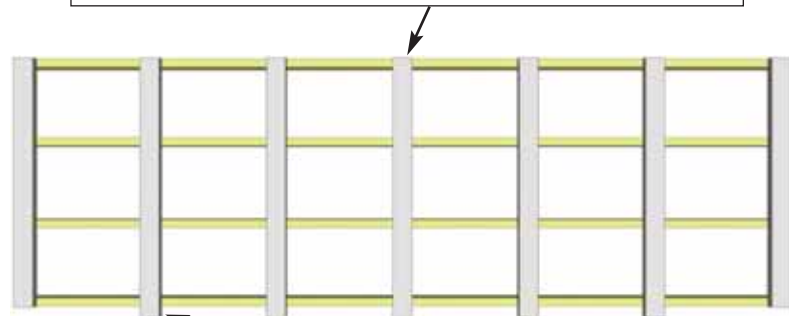

Long Floor Runners overhanging Floor Frame on front.

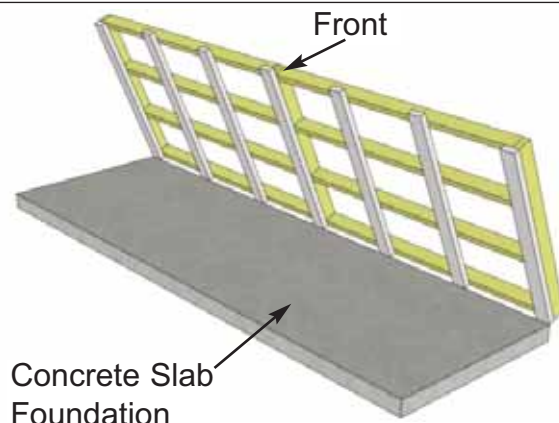

4. Align **1CC - Floor Runners - Long** evenly spaced as shown above and flush with the back of the Floor Frame. On the front, Runners will extend 2" past the Floor Frame to provide support for the Sliding Door Track later in the Assembly. Attach with **4 - 2 1/2" Screws** per Runner.

With Floor Runners attached, carefully flip the floor over and place on your foundation. **Caution** - Be careful when laying floor down not to bend or twist floor. **Note:** Having a level foundation is critical. Choosing a foundation will vary between regions. Typical foundations can be concrete pads or patio stones positioned underneath the floor runners.

Parts
1CC - Floor Runners - Long
 (1 1/2" x 3 1/2" x 47 1/2") x 5

Hardware
S1 - 2 1/2" Screws
 x 20 total

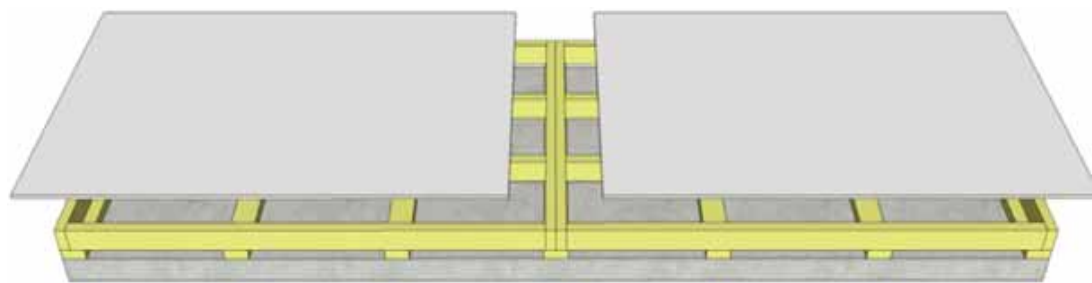

Note: Plywood is cut slightly smaller than floor framing. Keep plywood seams tight.

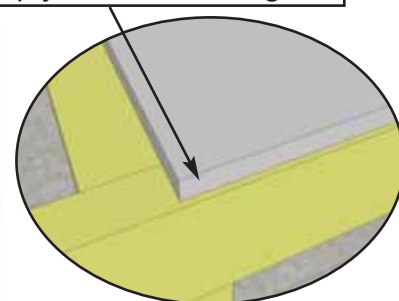

5. Position **1D - Plywood Floor** on top of completed floor frames. Plywood will sit slightly inset from outside of floor frame.

Parts
1D - Plywood Floor
 (5/8" x 45 3/8" x 70 5/8") x 2

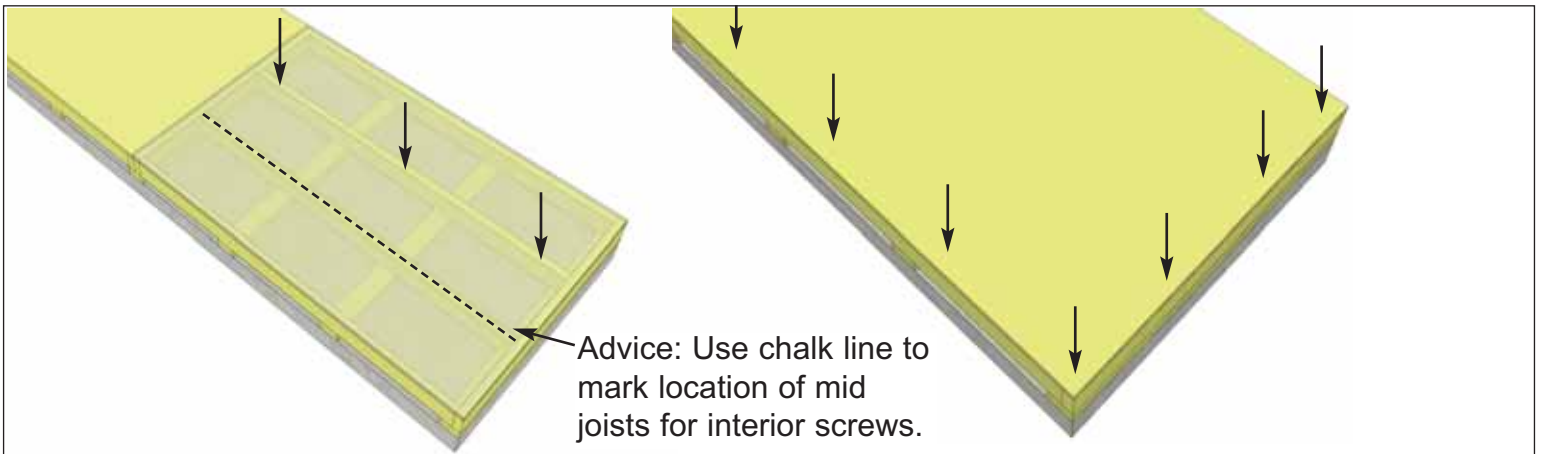

Advice: Use chalk line to mark location of mid joists for interior screws.

6. With Plywood positioned correctly on floor framing, attach with **1 1/4" Screws**. Use screws every 16" around perimeter of each floor section and 3 screws through each mid joists.

Hardware
S2 - 1 1/4" Screws
 x 40 total (approx.)

2. Wall Section

Exploded view of all parts necessary to complete the Wall Section. Identify all parts prior to starting.

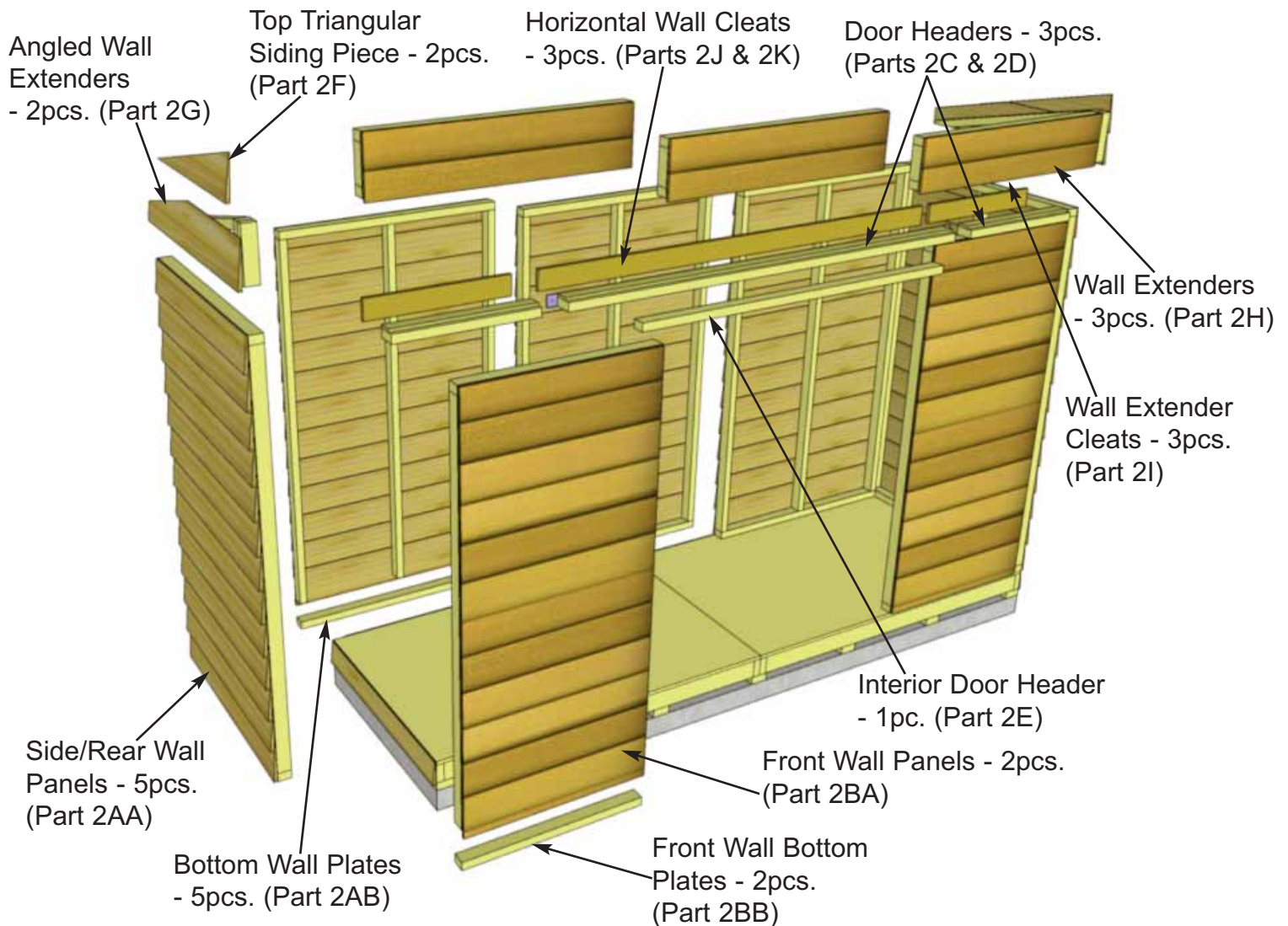

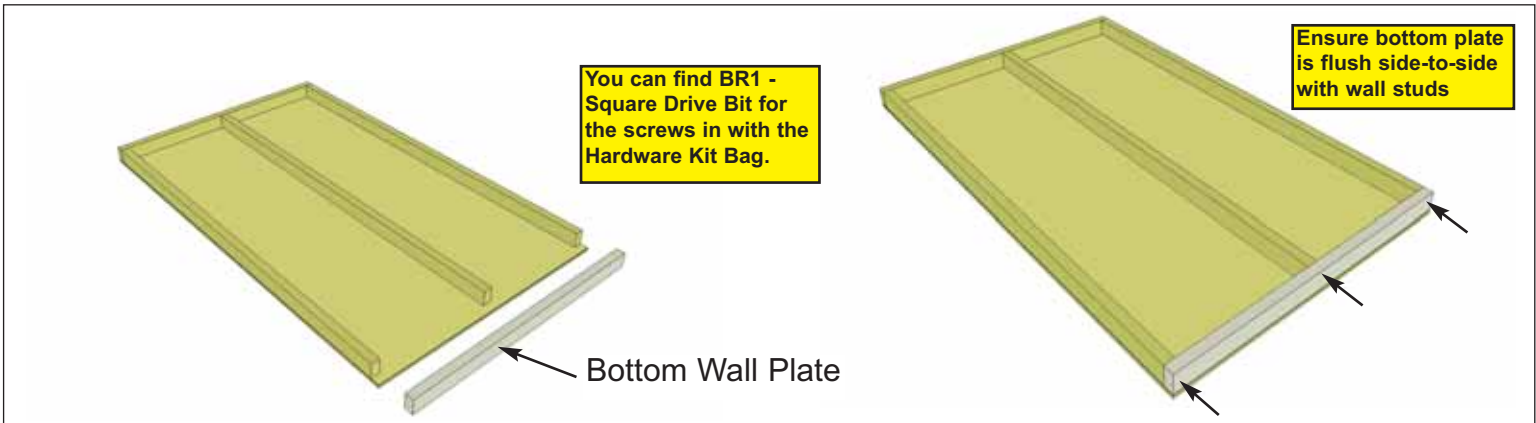

7. Carefully lay **2AA - Side/Rear Wall Panels** face down. Position and attach **2AB - Bottom Wall Plates** to bottom of wall studs of each wall panel with **3 - 2 1/2" Screws**. Position so plates are flush with framing. Complete 4 remaining solid walls.

Parts
2AA - Side/Rear Wall Panels (45 1/2" wide x 75" high) x 5
2AB - Bottom Wall Plates (1 5/8" x 2 1/2" x 45 1/2") x 5

Hardware
S1 - 2 1/2" Screws x 15 total

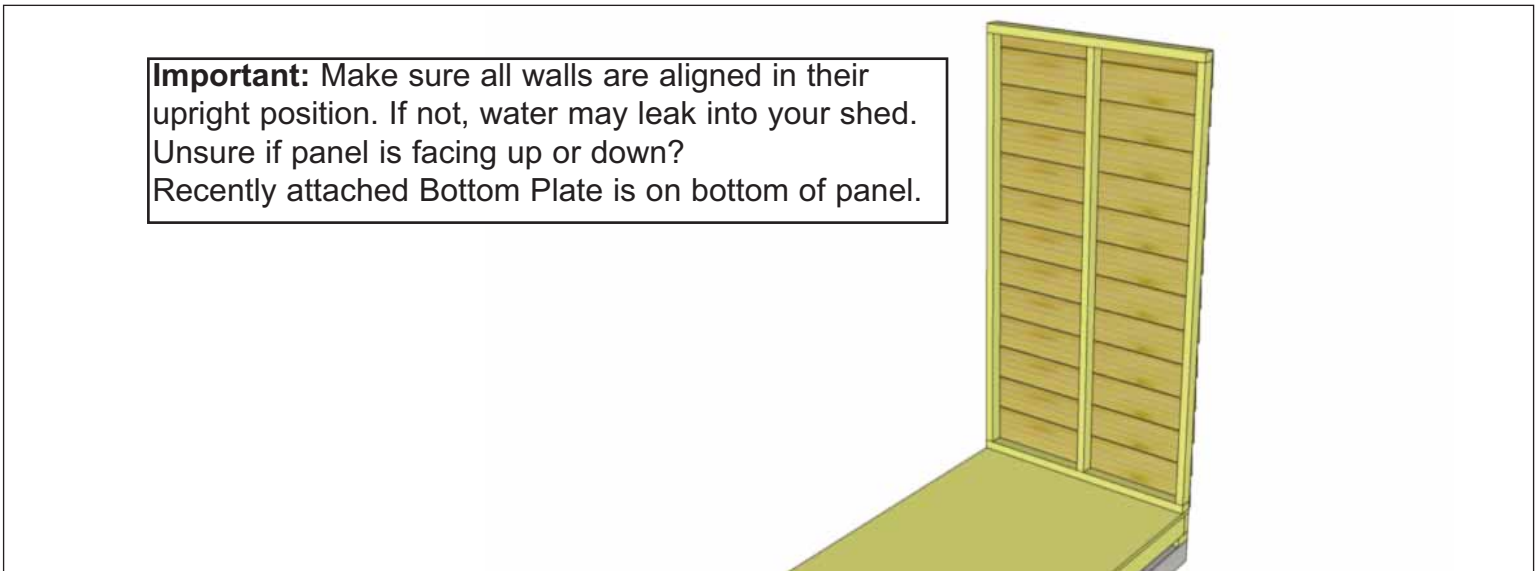

8. Starting on one side, position a Solid Wall Panel on top of plywood floor. The Wall Panel bottom framing will sit flush with the outside of the floor frame. Wall siding will overhang the floor.

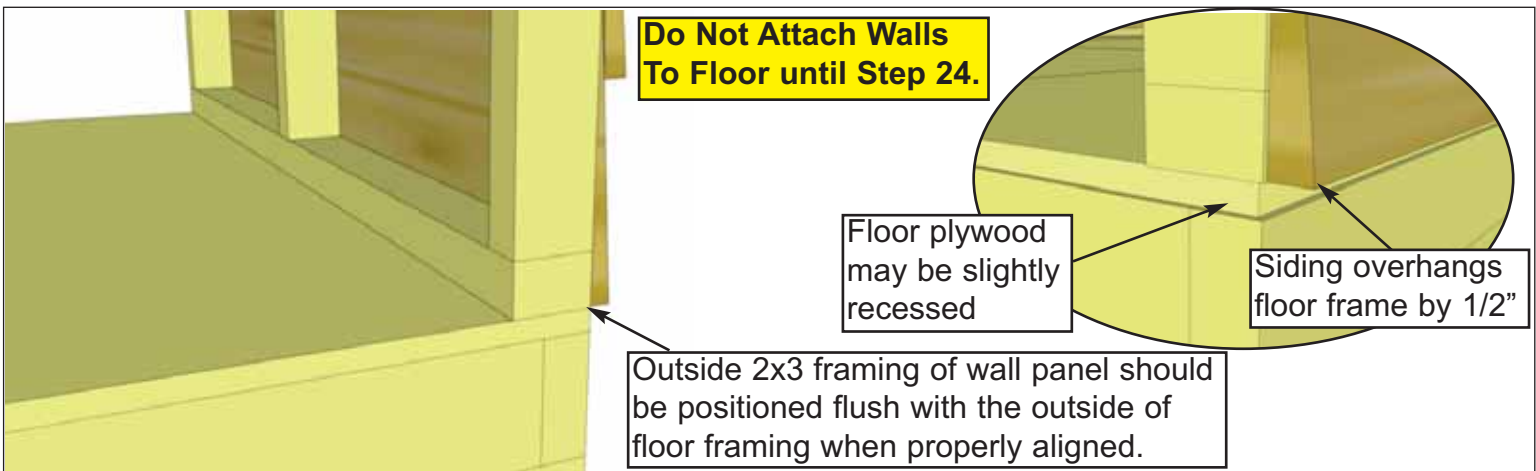

9. The side wall panels will sit even with the floor frame and the rear wall panels will be sandwiched between the side wall panels. The floor plywood may be slightly recessed.
Note: Siding will overhang the floor frame by approximately 1/2".

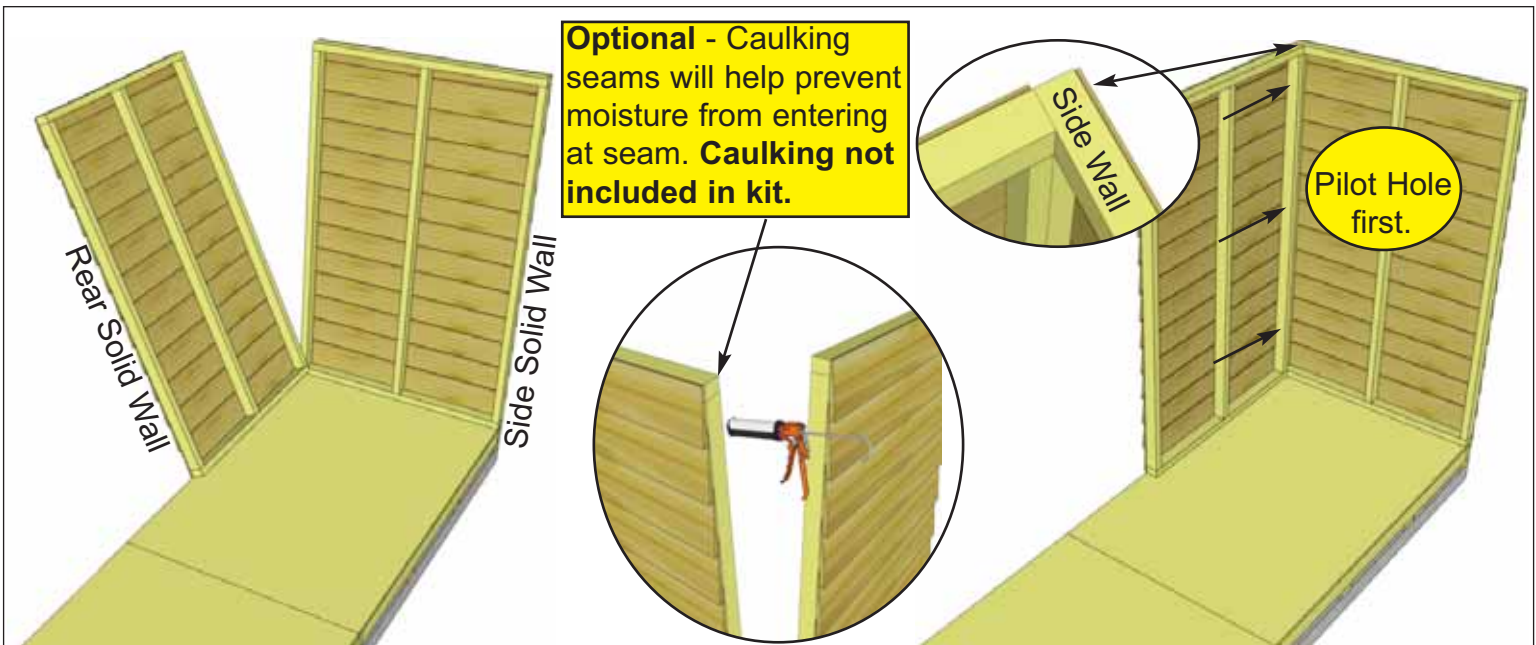

10. Position rear solid wall into place on plywood floor. Butt both vertical wall studs of side and rear walls together and attach with **3 - 2 1/2" Screws**. Screw at the bottom, middle and top of stud to secure properly.
Note: Drill pilot holes in studs to prevent splitting.

Hardware (Steps 10 - 12)
S1 - 2 1/2" Screws
 x 12 total

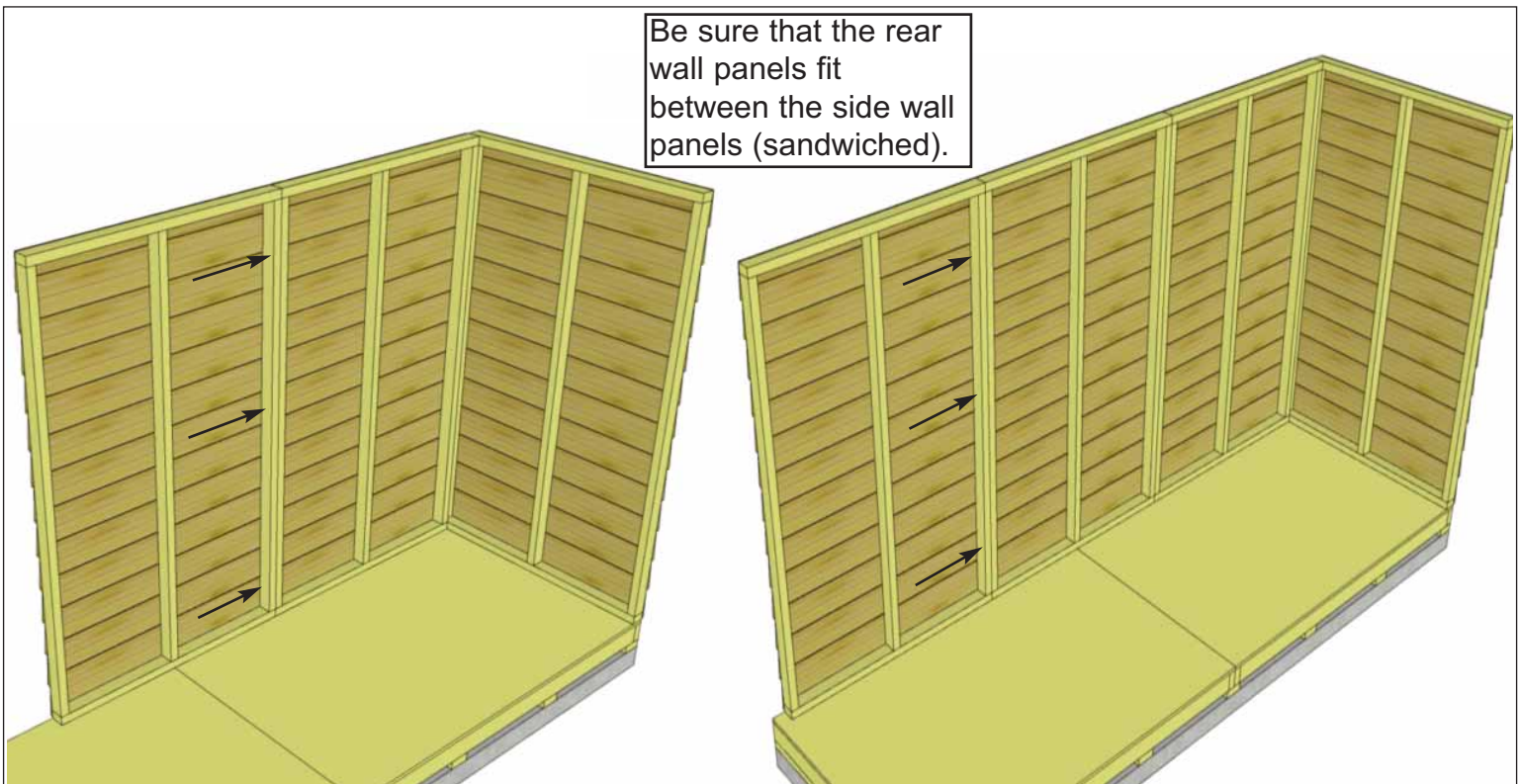

11. With the corner wall attachment complete, position a second rear wall panel in place so bottom 2x3 wall framing is sitting flush with outside floor joists. Wall siding should overhang floor by approximately 1/2". When positioned correctly, attach both side wall panel studs together as per **Step 10**.



12. Complete remaining side wall attachment as per **Steps 10 - 11.**

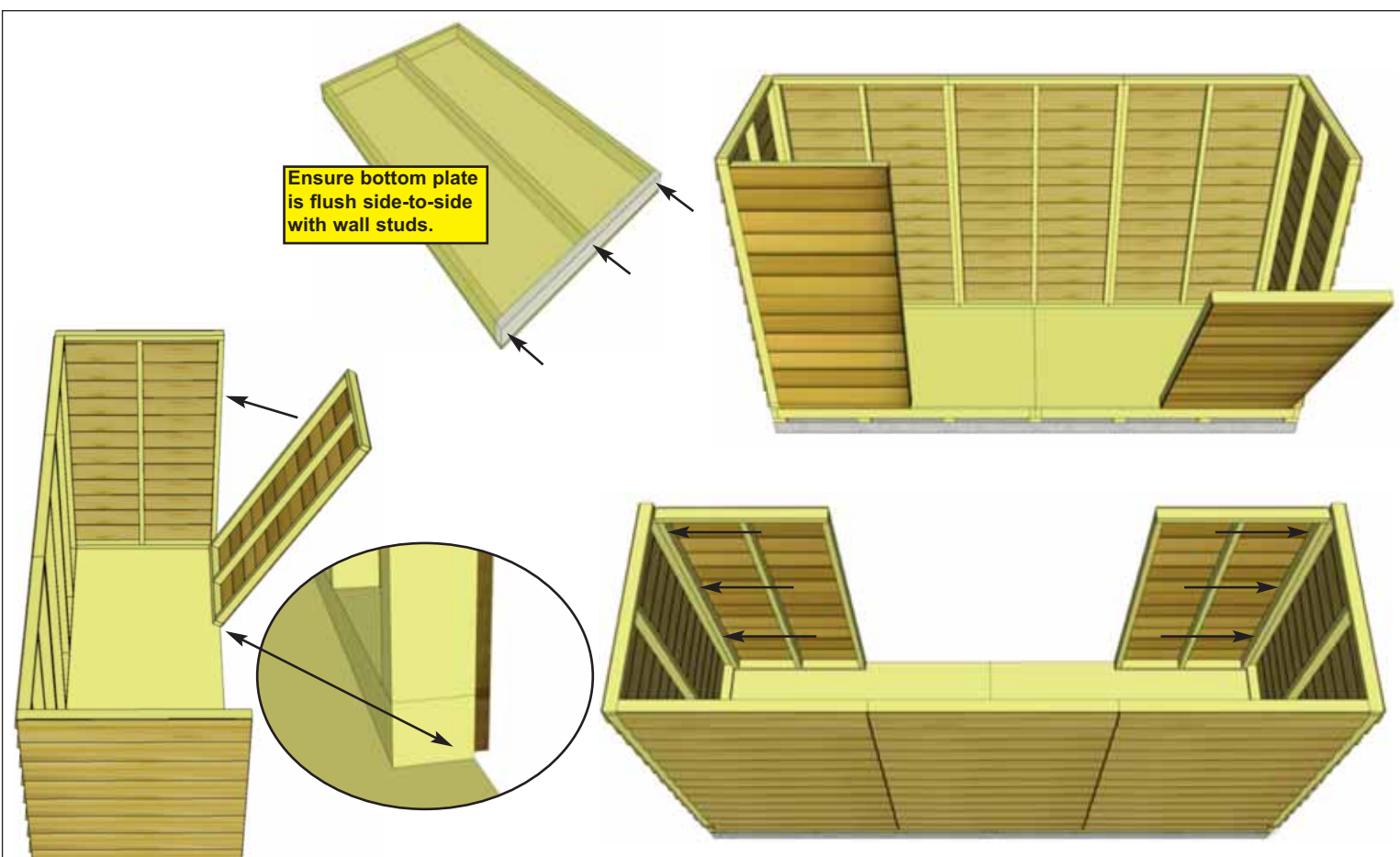

13. Carefully lay **2BA - Front Wall Panels** face down. Position and attach **2BB - Bottom Wall Plates** to bottom of wall studs of each wall panel with **3 - 2 1/2" Screws** as per **Step 7**. Complete other remaining Front Wall.

Place Front Walls so wall framing is flush with floor frame and siding overhangs. Attach with **3 - 2 1/2" Screws** per panel as per **Steps 10 - 12.**

Parts

2BA - Front Wall Panels
(35" wide x 73" high) x 2
2BB - Bottom Wall Plates
(1 5/8" x 2 1/2" x 35") x 2

Hardware

S1 - 2 1/2" Screws x 12 total

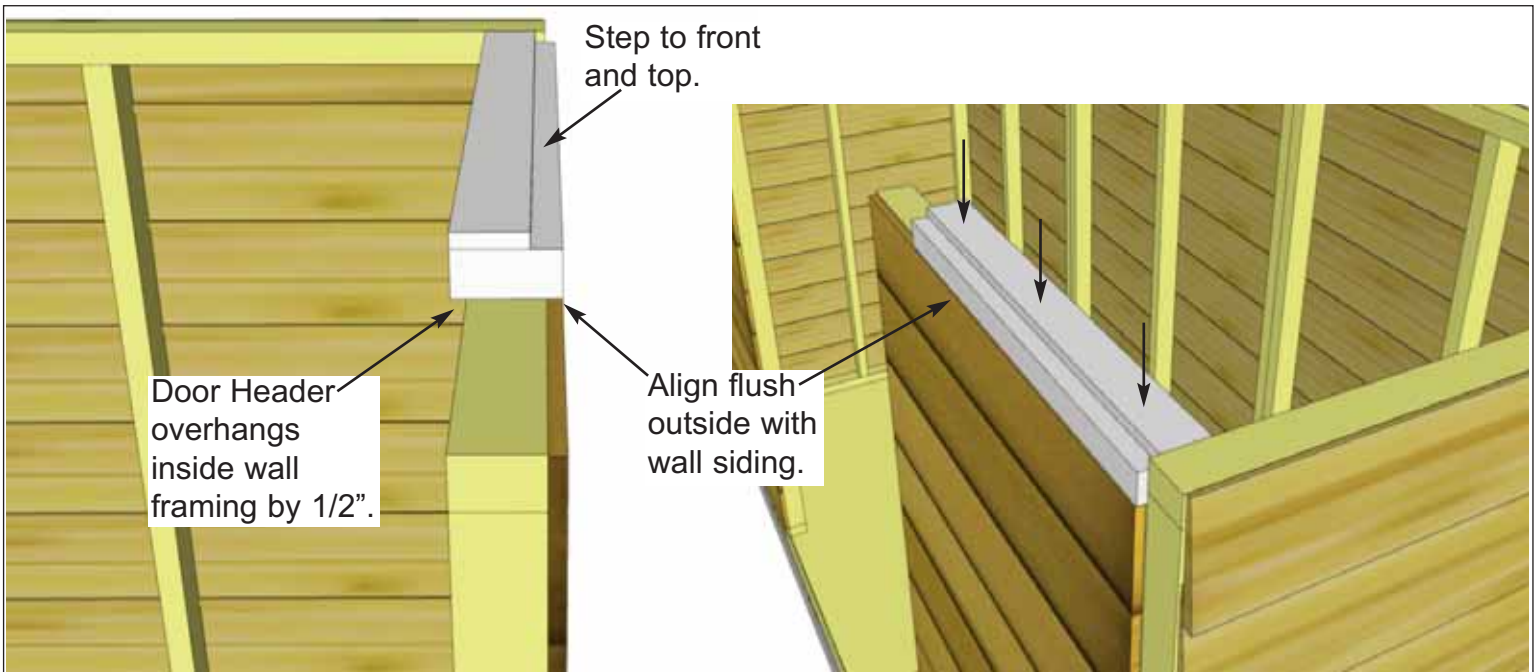

14. Position **2C - Door Header - Short** on top of wall stud so it is flush on the outside with the wall siding. Attach by screwing down into top wall framing with **3 - 3" Screws**.

Parts (Step 14 - 15)
2C - Door Headers - Short
 (2" x 3 1/2" x 26 1/4") x 2
2D - Door Header - Long
 (2" x 3 1/2" x 84") x 1

Hardware (Step 14 - 15)
S4 - 3" Screws
 x 10 total
S2 - 1 1/4" Screws
 x 4 total

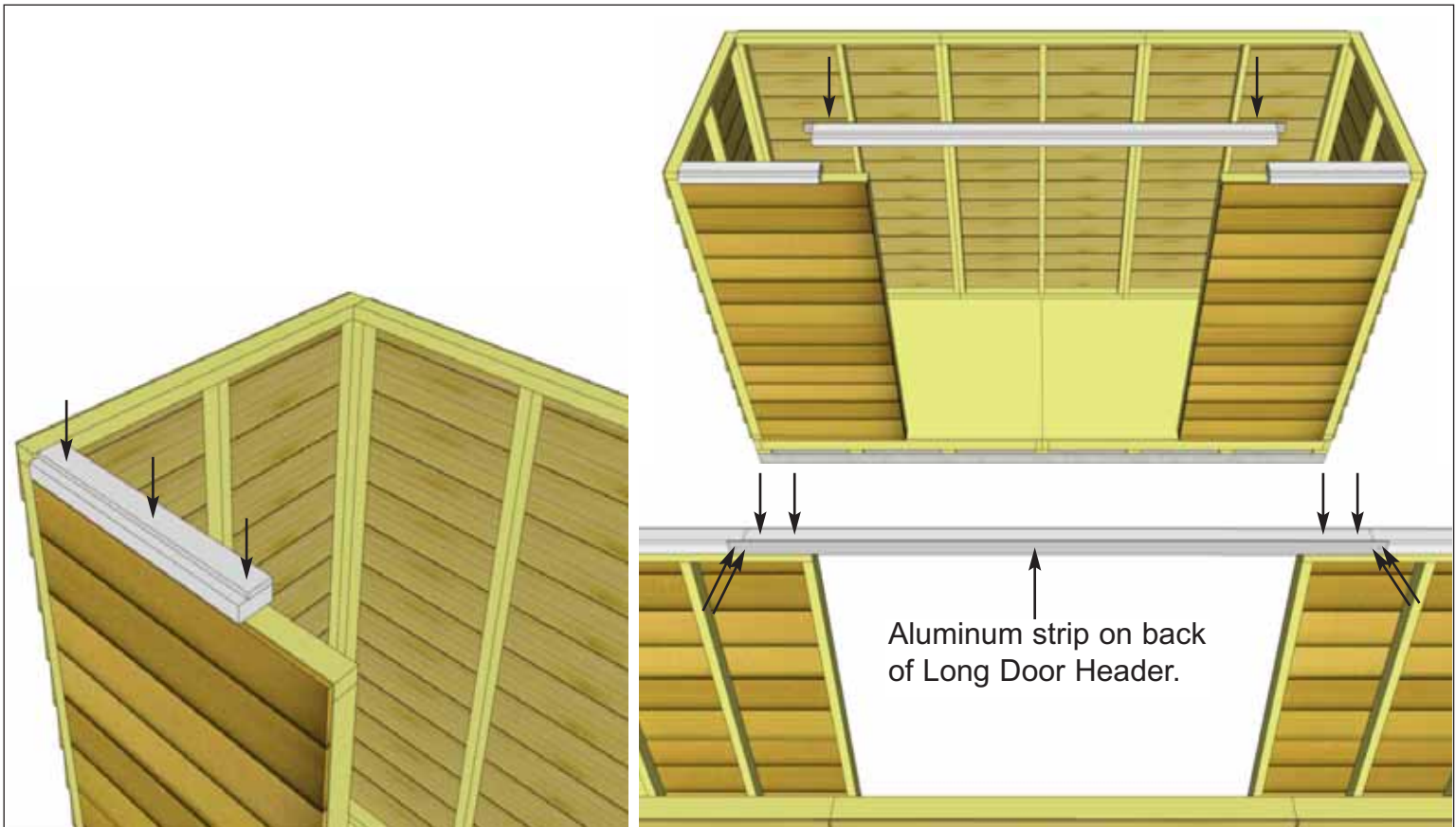

15. Attach **2C - Door Header - Short** to other side. Position and attach **2D - Door Header - Long** between short door headers. The Long Door Header has an aluminum strip attached to the back for added support. Attach by screwing down into wall framing with **2 - 3" Screws** per side. Fasten aluminum strip to short headers with **2 - 1 1/4" Screws** per side.

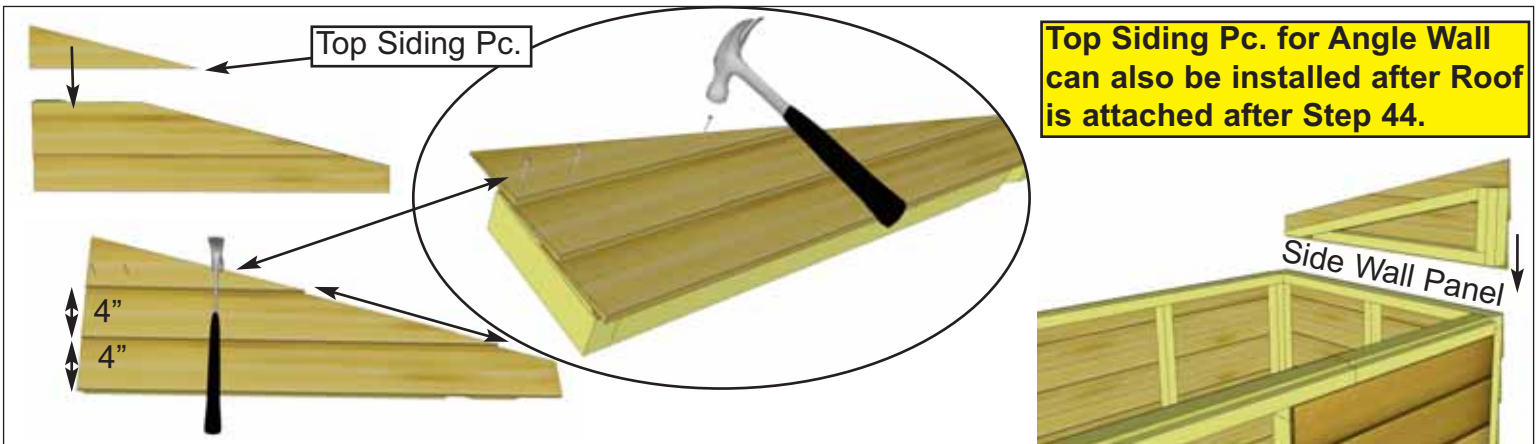

Top Siding Pc. for Angle Wall can also be installed after Roof is attached after Step 44.

16. Position **2F - Top Triangular Siding Piece** onto **2G - Angle Wall Extender** and align as shown above. Attach with **3 - 1 1/2" Finishing Nails** to top frame of extender wall. There are left/right top siding pieces. Use rough surface side out. Place finished wall extender on side wall panel frame. Complete both sides now. **Note:** Bottom siding of wall extender will overhang and cover siding of side wall.

- Parts
2G - Angle Wall Extenders - L/R
 (2G - 45 1/2" wide) x 2
2F - Top Triangular Siding Piece
 (2F - Left/Right) x 2
- Hardware
N1 - 1 1/2" Finishing Nails x 6 total

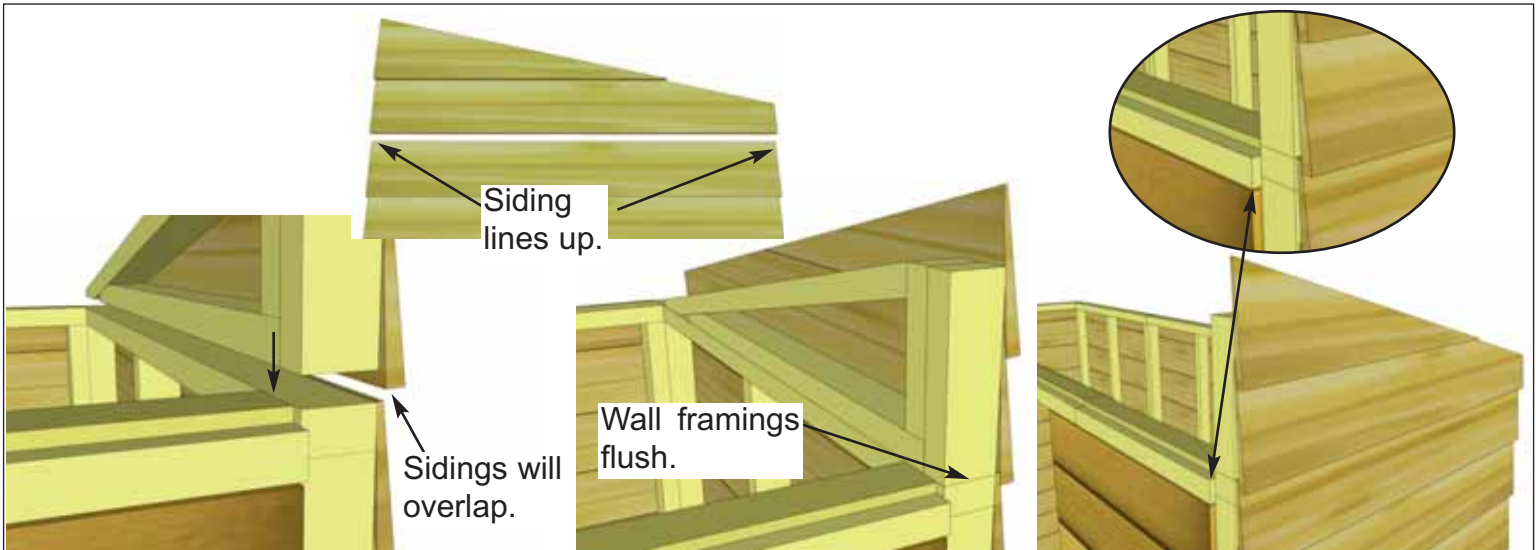

17. Align wall framing of Angled Wall Extender and Side Wall so they are flush at the front. The siding for both walls should also align evenly from front to back.



18. With Angled Wall Extender and Side Wall aligned correctly, secure together from the inside with **4 - 2 1/2" Screws**.

- Hardware (Steps 18 - 19)
S1 - 2 1/2" Screws x 8 total

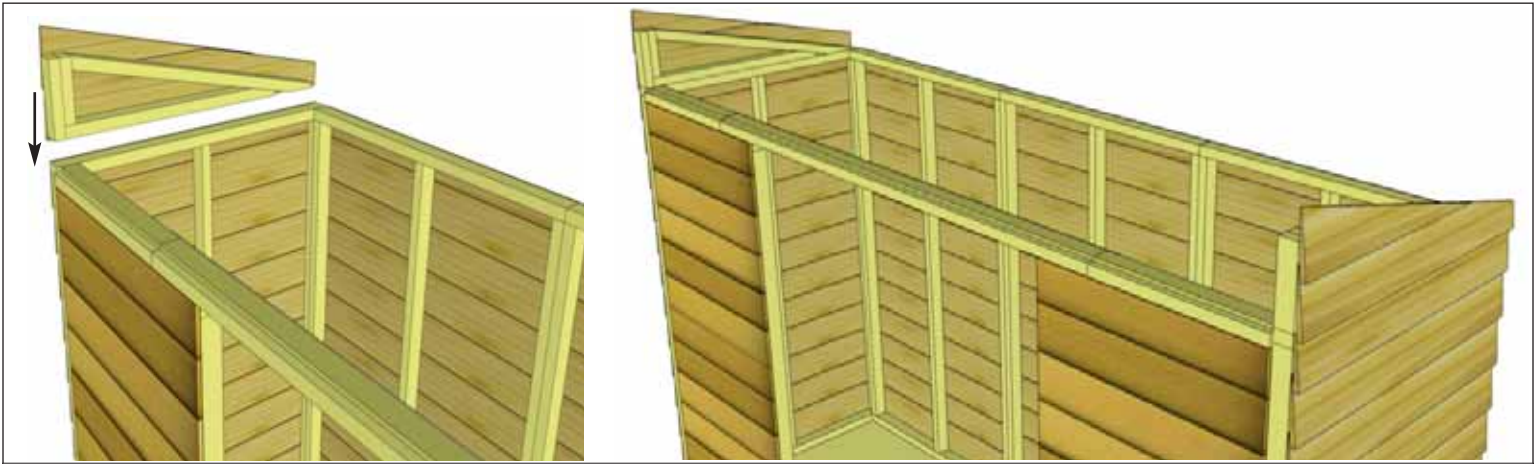

19. Complete opposite Angled Wall Extender positioning and attachment as per **Step 18**.

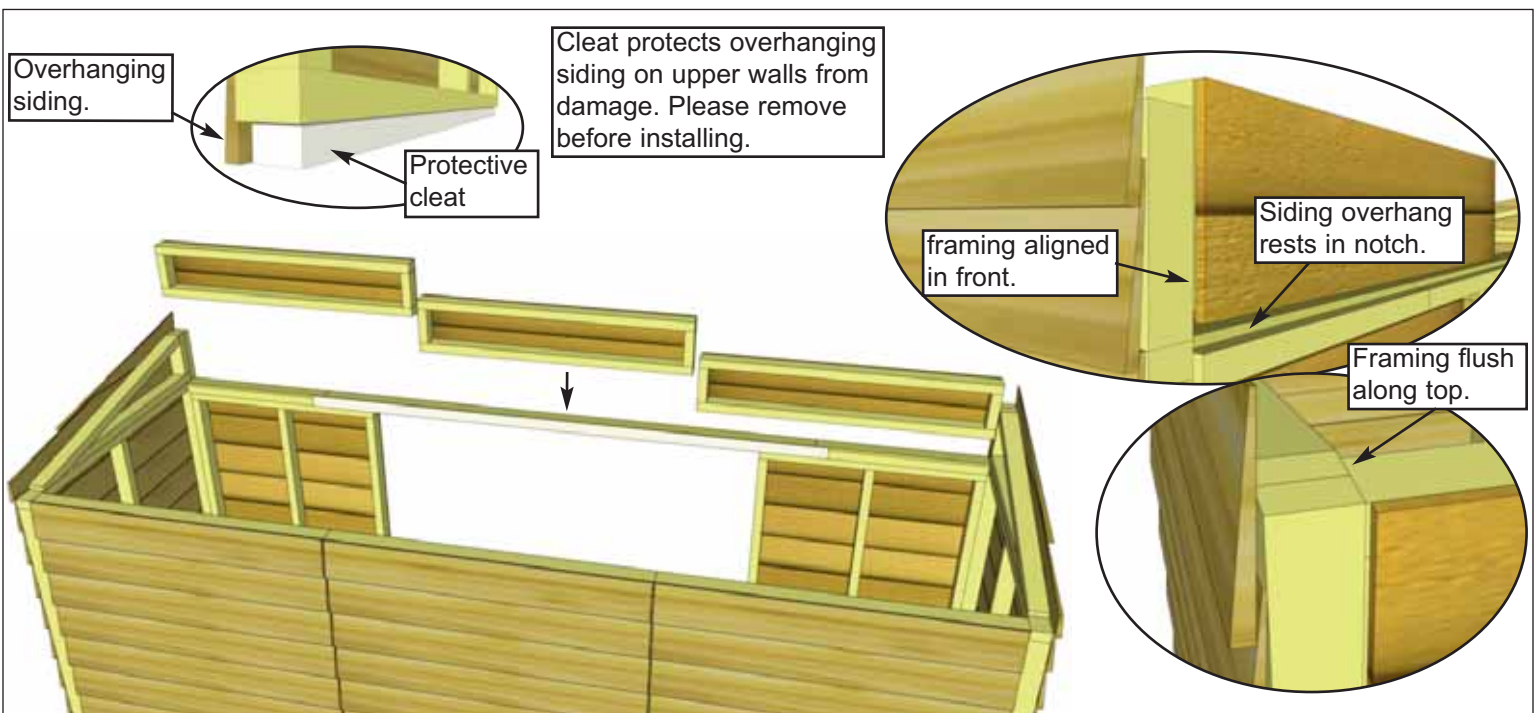

20. Place **2H - Extender Walls** on top of Door Header so that framing is aligned with Angle Wall Extender framing in front as shown above. With framing aligned, attach Extender Walls to Door Header and other extenders with **4 - 2 1/2" Screws** each as shown below.

<u>Parts</u>
2H - Extender Walls (2H - 45 1/2" wide) x 3
<u>Hardware</u>
S1 - 2 1/2" Screws x 12 total

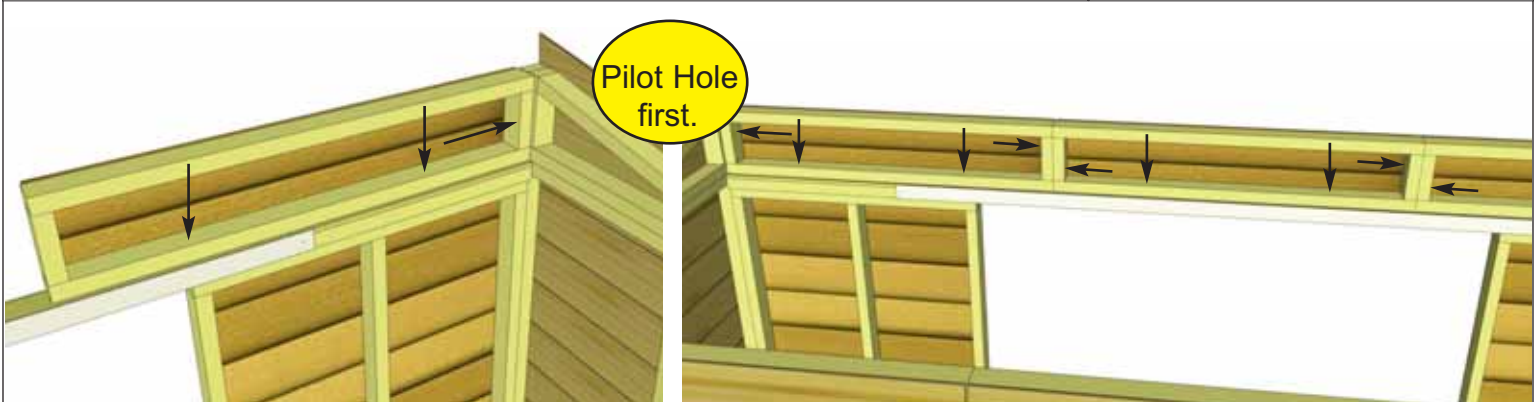

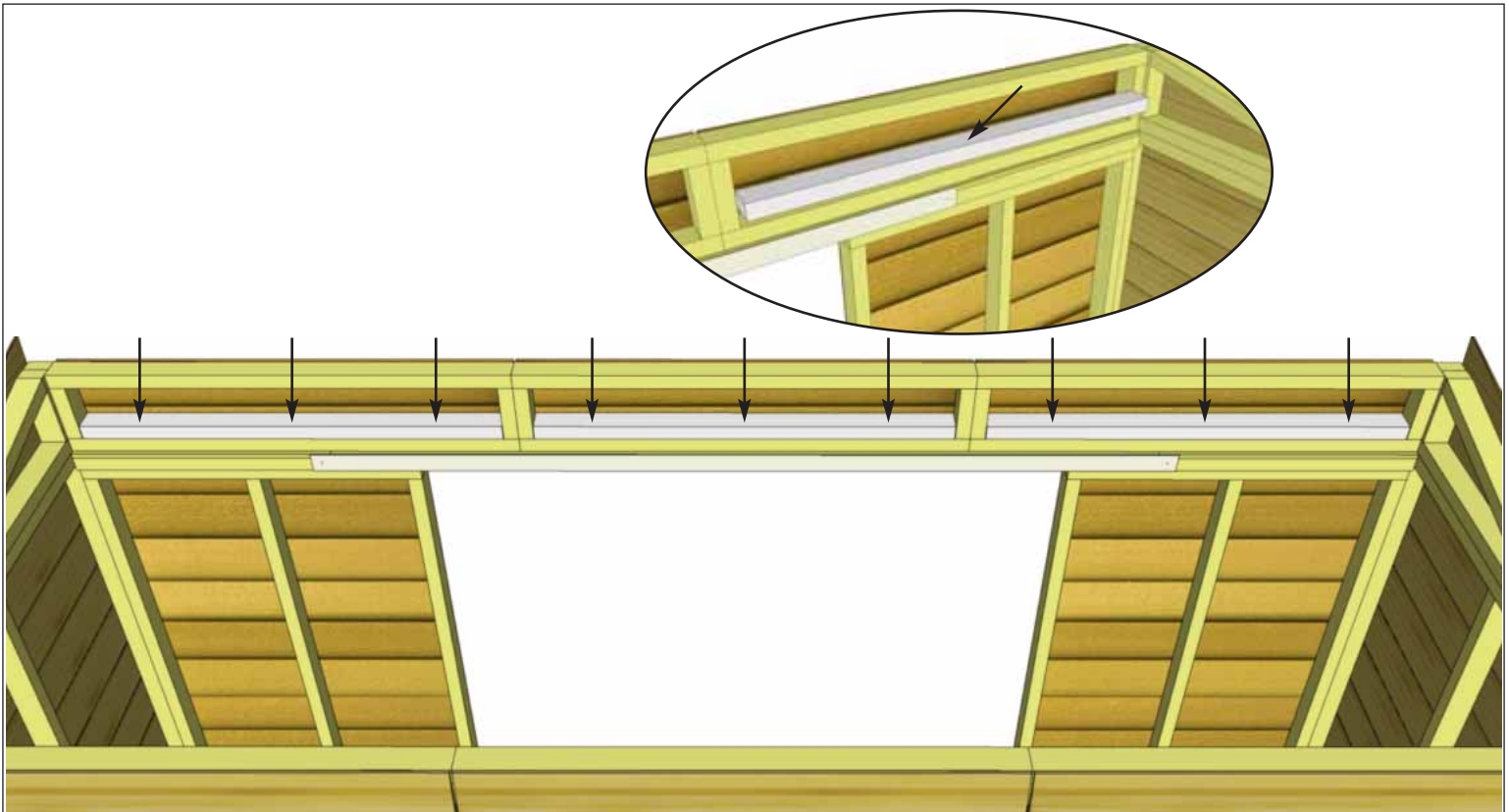

21. With Extender Walls attached, position **2I - Extender Wall Cleats** in the lower section of each Extender Wall. Attach with **3 - 2 1/2" Screws** per cleat.

Parts
2I - Extender Wall Cleats
 (1 1/2" x 2 1/2" x 42 3/8") x 3

Hardware
S1 - 2 1/2" Screws
 x 9 total

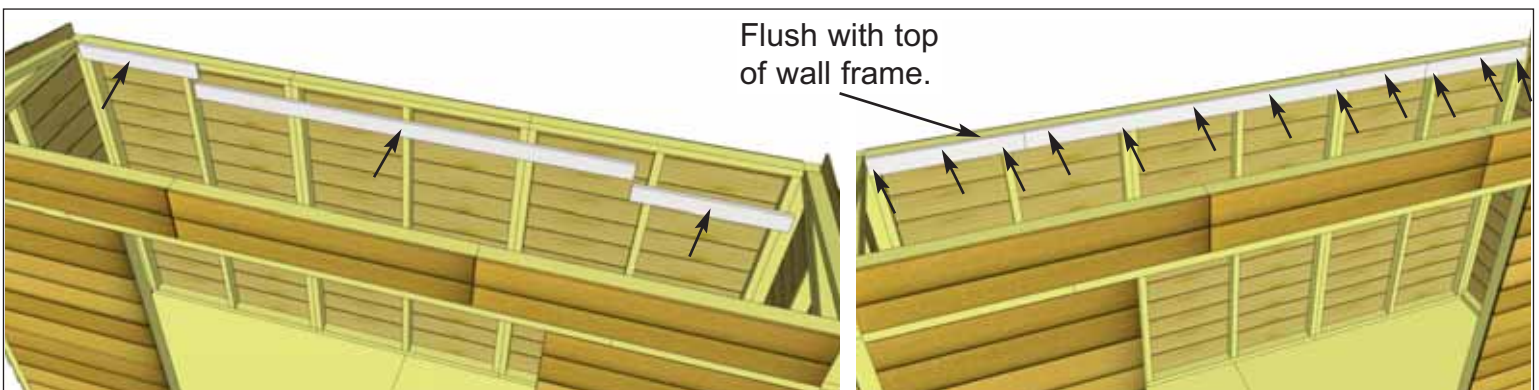

22. Align **2J & 2K - Horizontal Wall Cleats** flush with top of Rear Wall framing. Attach with **3 - 1 1/4" Screws** per short cleat and **6 - 1 1/4" Screws** on the long cleat.

Parts
2J - Horizontal Wall Cleat - Long
 (3/4" x 3 1/2" x 84") x 1
2K - Horizontal Wall Cleats - Short
 (3/4" x 3 1/2" x 26 1/4") x 2

Hardware
S2 - 1 1/4" Screws
 x 12 total

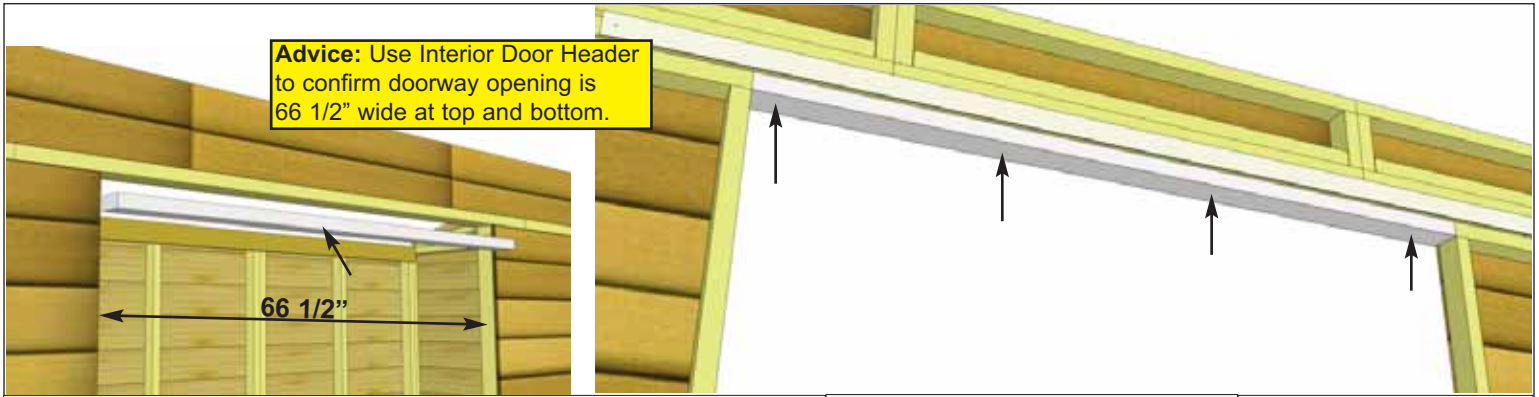

23. Attach **2E - Interior Door Header** as shown above. Align with top framing of front walls. Attach with **4 - 2 1/2" Screws**.

Parts
2E - Interior Door Header
 (1 1/2" x 3" x 66 1/2") x 1

Hardware
S1 - 2 1/2" Screws
 x 4 total

Advice: Prior to screwing down floor and installing rafters, take time to confirm your walls are level, square and plumb.

Measure diagonal at top and bottom of walls corner-to-corner. This should be approximately 142 1/4". More importantly, if measurements are not within 1/4", your walls are not square.

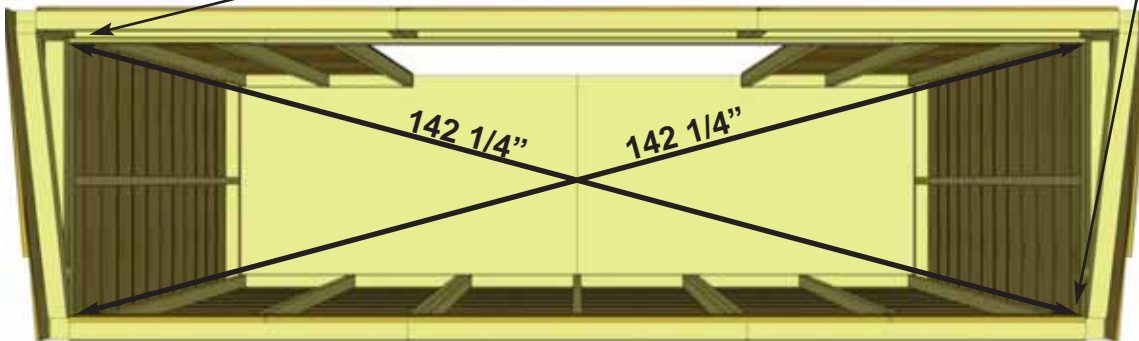
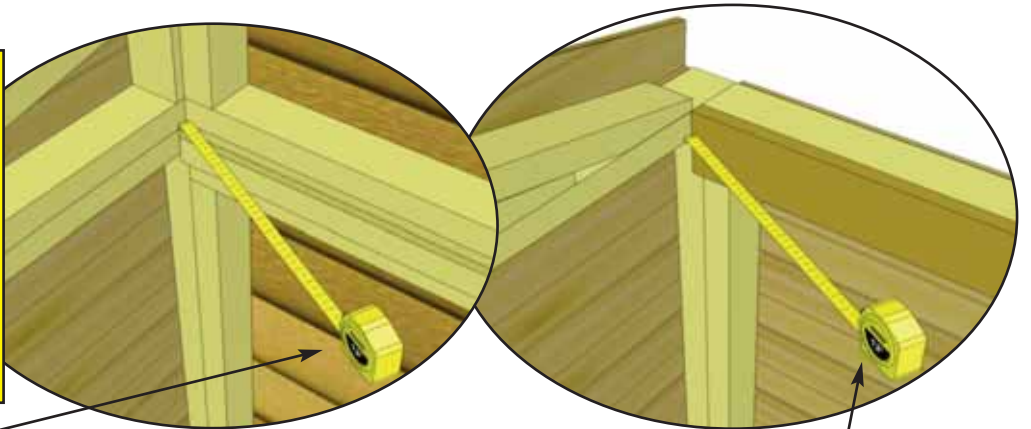

Optional - Caulking seams will help prevent moisture from entering at seam. Caulking not included in kit.

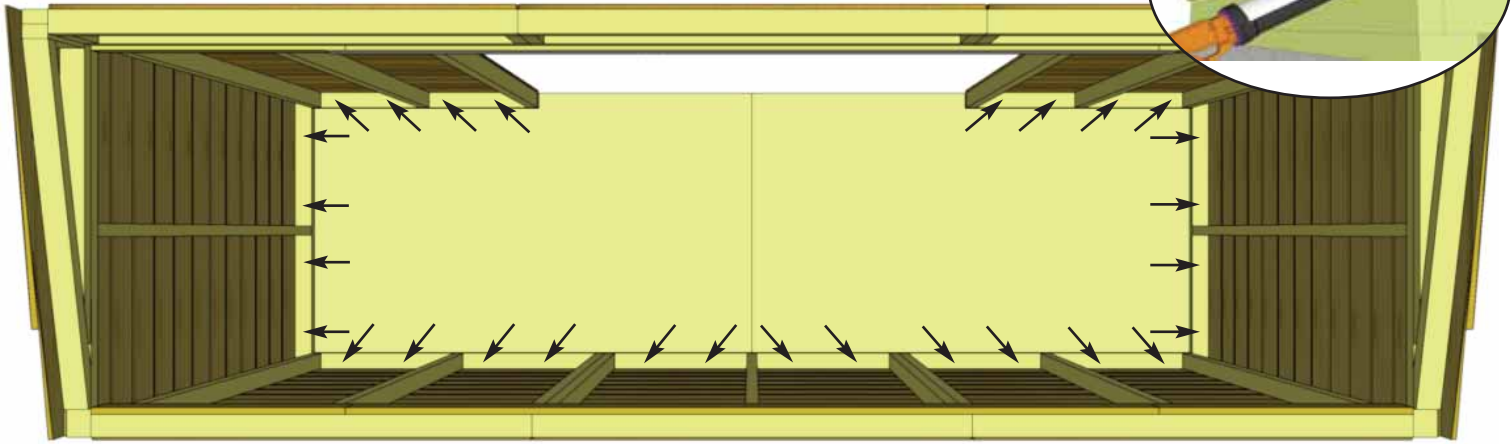
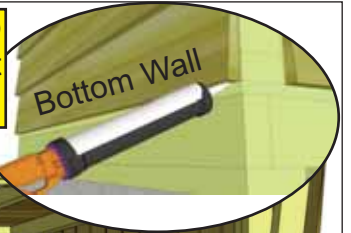

24. To complete Wall Section, attach bottom 2x3 wall plates to plywood floor with 2 - 2 1/2" Screws per wall section. Prior to securing, make sure wall panels are aligned correctly on the floor. Refer to **Step 9**. Wall siding should overhang floor while 2x3 wall plates should sit flush with floor.

Hardware
S1 - 2 1/2" Screws
 x 28 total

3. Rafter and Roof Section

Exploded view of all parts necessary to complete the Rafter and Roof Section. Identify all parts prior to starting.

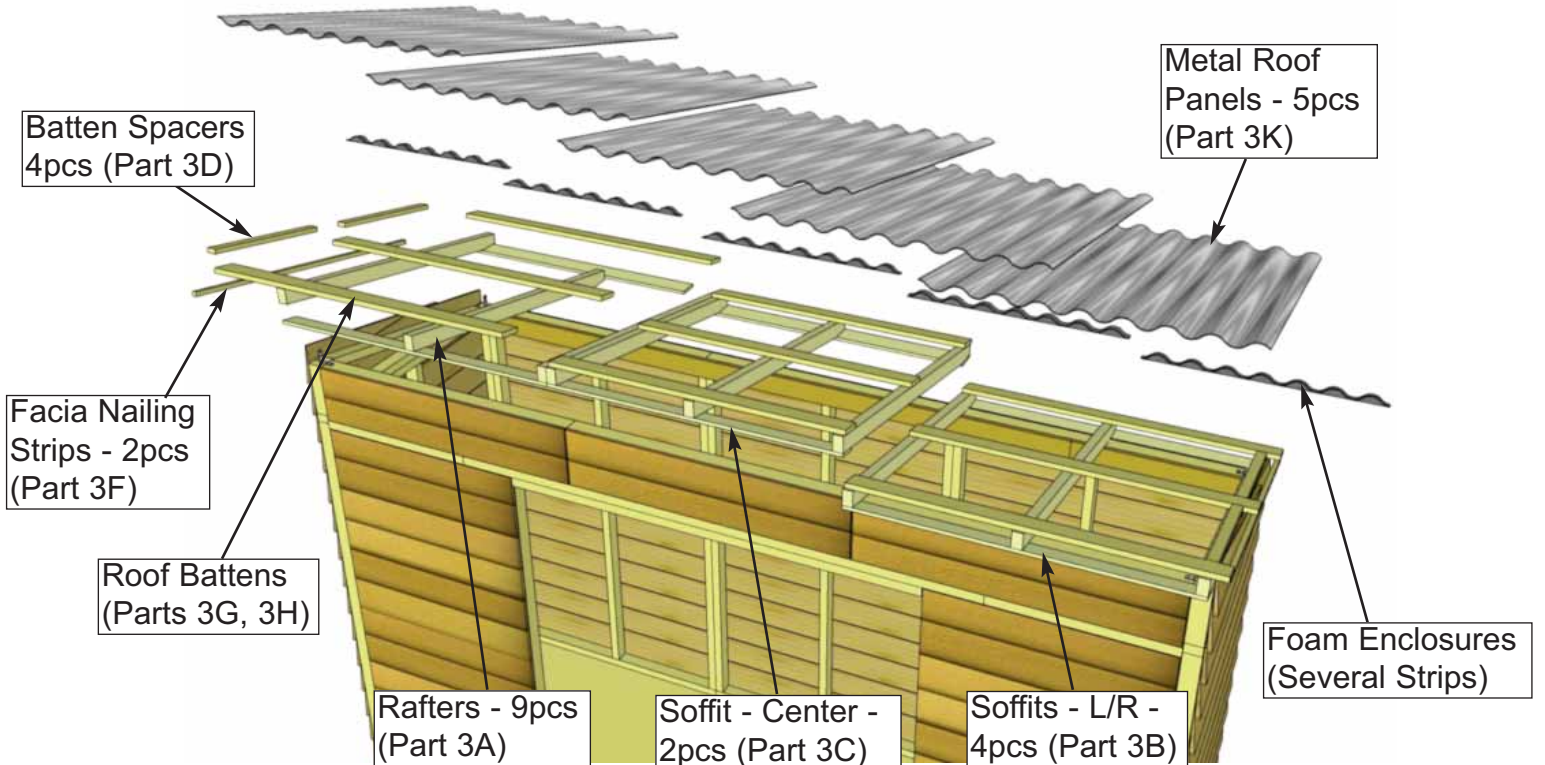

Note: We recommend you drill a 1/8" pilot hole for each screw, to avoid splitting wood. The hole depth should be equal to 3/4 the length of screw.

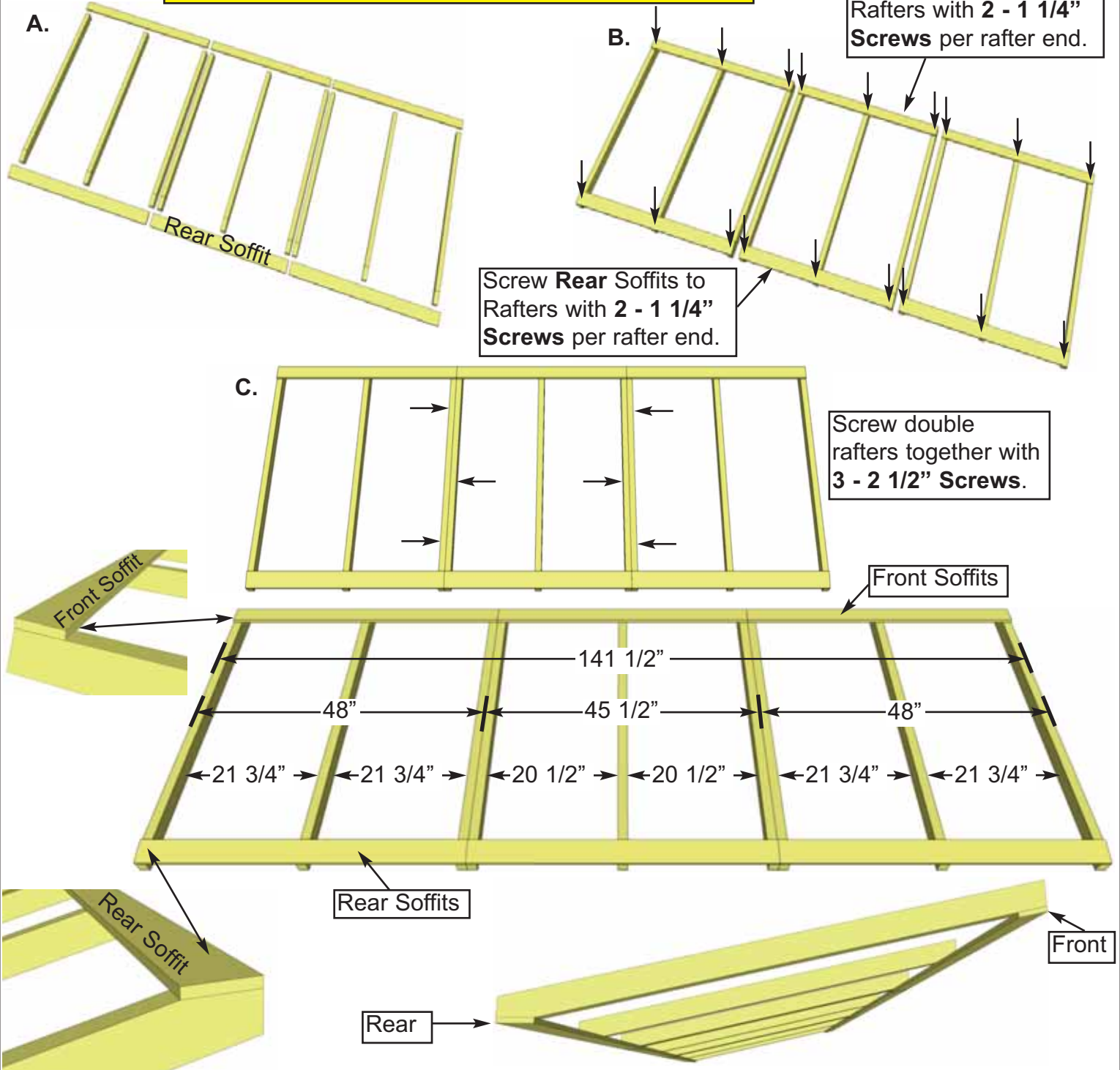

25. Locate **3A - Rafters**, **3B & 3C - Soffits**. Lay out on level ground and assemble as shown above in Illustrations **A** through **C** below. Attach Soffit Boards flush to end of outside rafters. Attach Front Soffits with **2 - 1 1/4" Screws** per rafter end. Attach Rear Soffits with **2 - 1 1/4" Screws** per rafter end. **Important:** Drill pilot holes in Soffit ends to prevent splitting. Attach double rafters as illustrated above with **3 - 2 1/2" Screws** per rafter/rafter connection.

Parts	
3A - Rafters (1 1/2" x 2 1/2" x 54") x 9	
3B - Front & Rear Soffits - L/R (1/2" x 3 1/2" x 48") x 4	
3C - Front & Rear Soffit - Center (1/2" x 3 1/2" x 45 1/2") x 2	

Hardware	
S1 - 2 1/2" Screws x 24 total	
S2 - 1 1/4" Screws x 18 total	

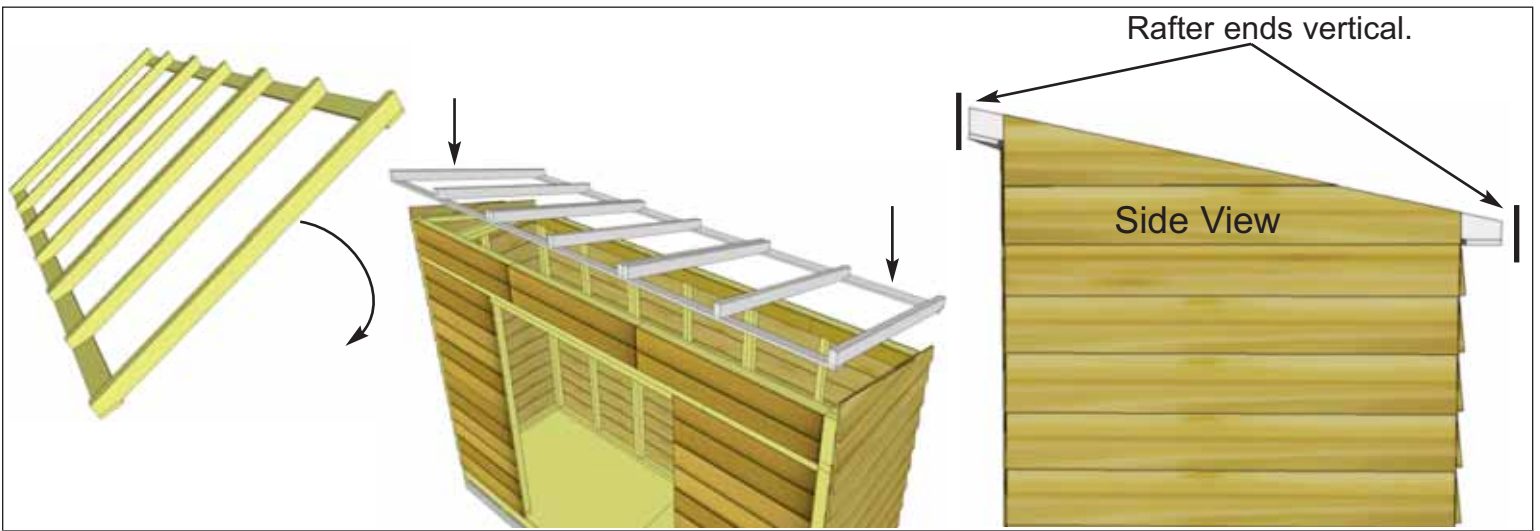

26. Carefully flip completed Rafter Section over so Front Soffit is facing the front and place on GardenSaver walls. **Note:** Double check that your Rafter Section is positioned correctly by ensuring the ends of the Rafters are sloped vertically as shown above.

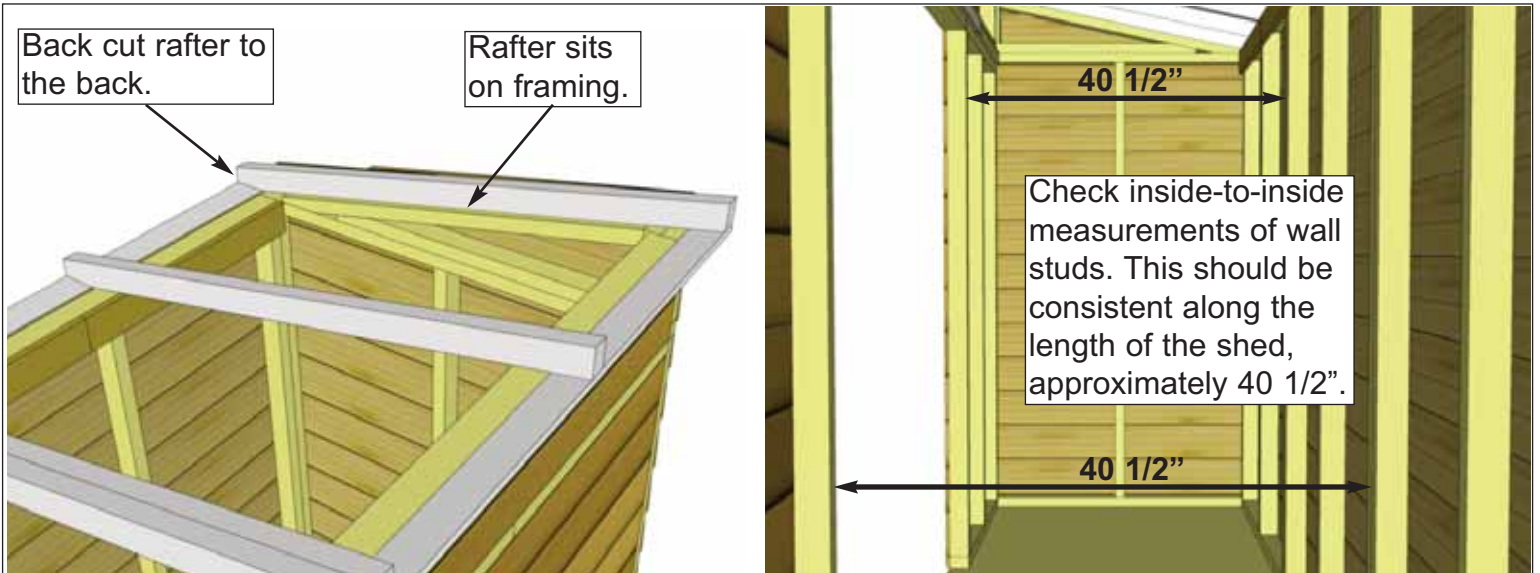

27. Position completed Rafter Section on top of walls. Outside Rafters will sit on Extension Wall framing and be positioned equally from side to side.



28. When Rafter Section is positioned correctly, both Front and Rear Soffits will sit approximately 1/8" away from wall siding. This can vary slightly.

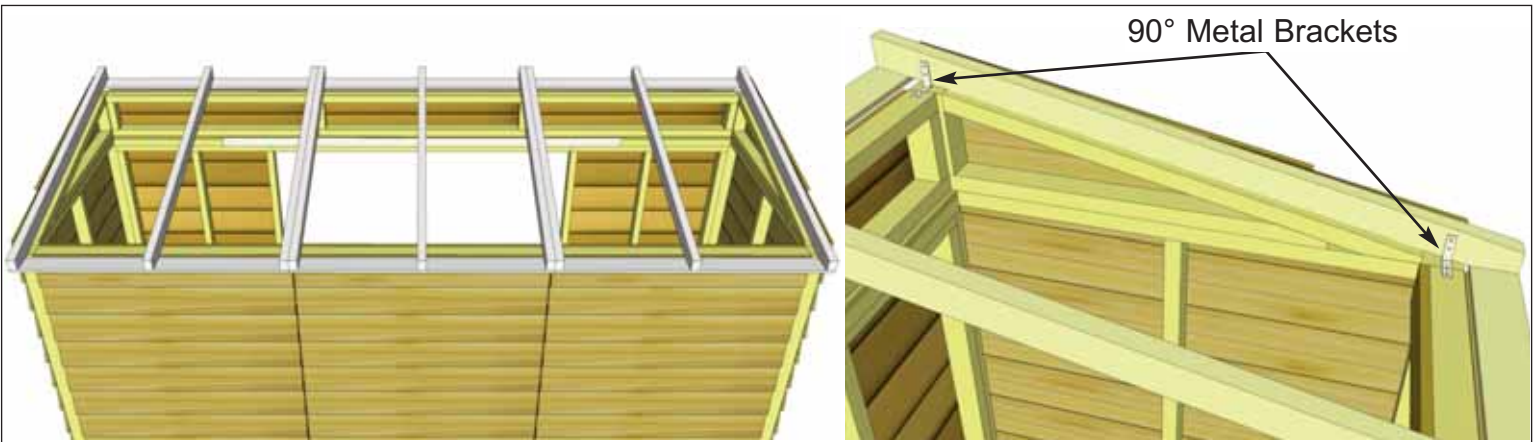

29. With Rafter Section correctly aligned, secure rafters to walls using **2 - 90° Metal Brackets** per side. Attach each brackets with **4 - 1 1/4" Screws**. Screw into Wall Extender framing at the front and Wall Panel top framing at the rear. Complete both sides.

Hardware
Y2 - 90° Metal Bracket
 x 4 total
S2 - 1 1/4" Screws
 x 16 total

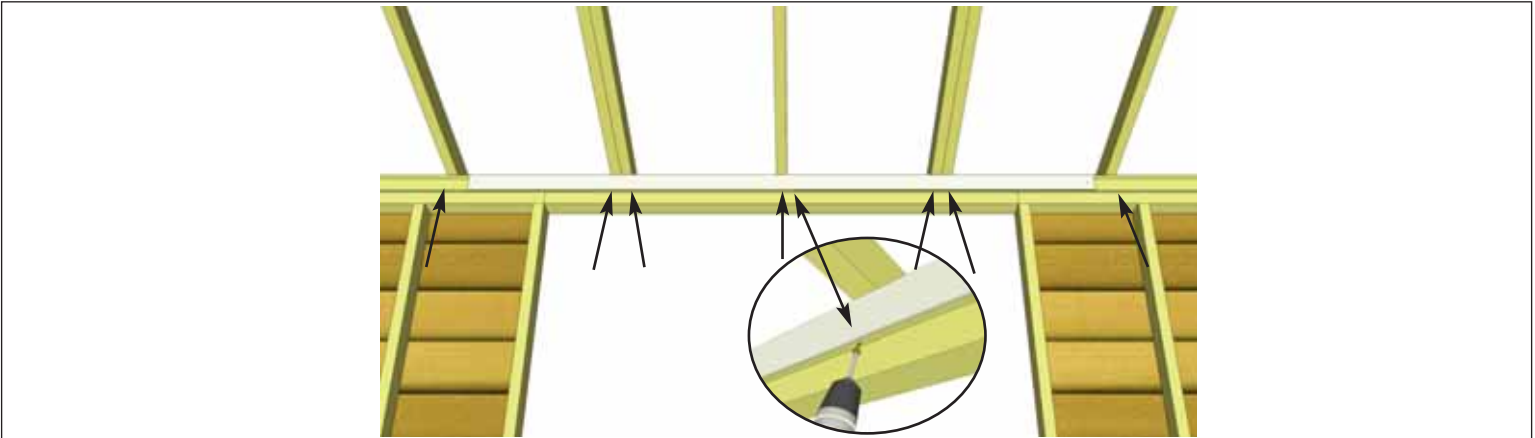

30. With outside rafters properly secured, attach remaining interior rafters using **1 - 3" Screw** per rafter end at the front of the shed. Screw into rafters from inside of Header on an angle.

Hardware
S4 - 3" Screws
 x 7 total

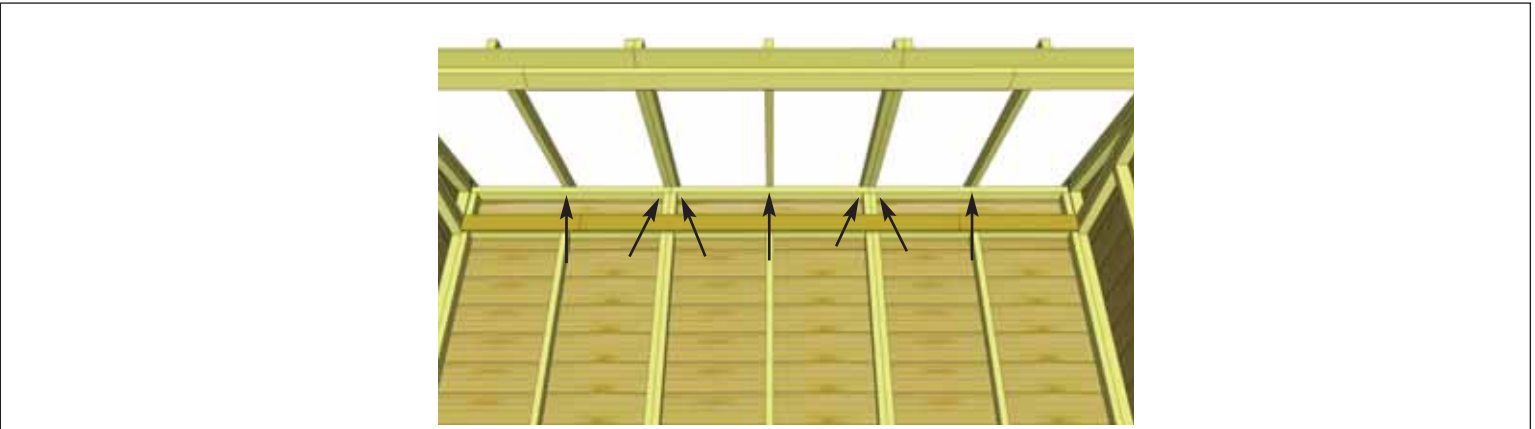

31. With outside rafters properly secured, attach remaining interior rafters using **1 - 3" Screw** per rafter end at the rear of the shed. Screw into rafters from inside of Extender Wall Framing.

Hardware
S4 - 3" Screws
 x 7 total

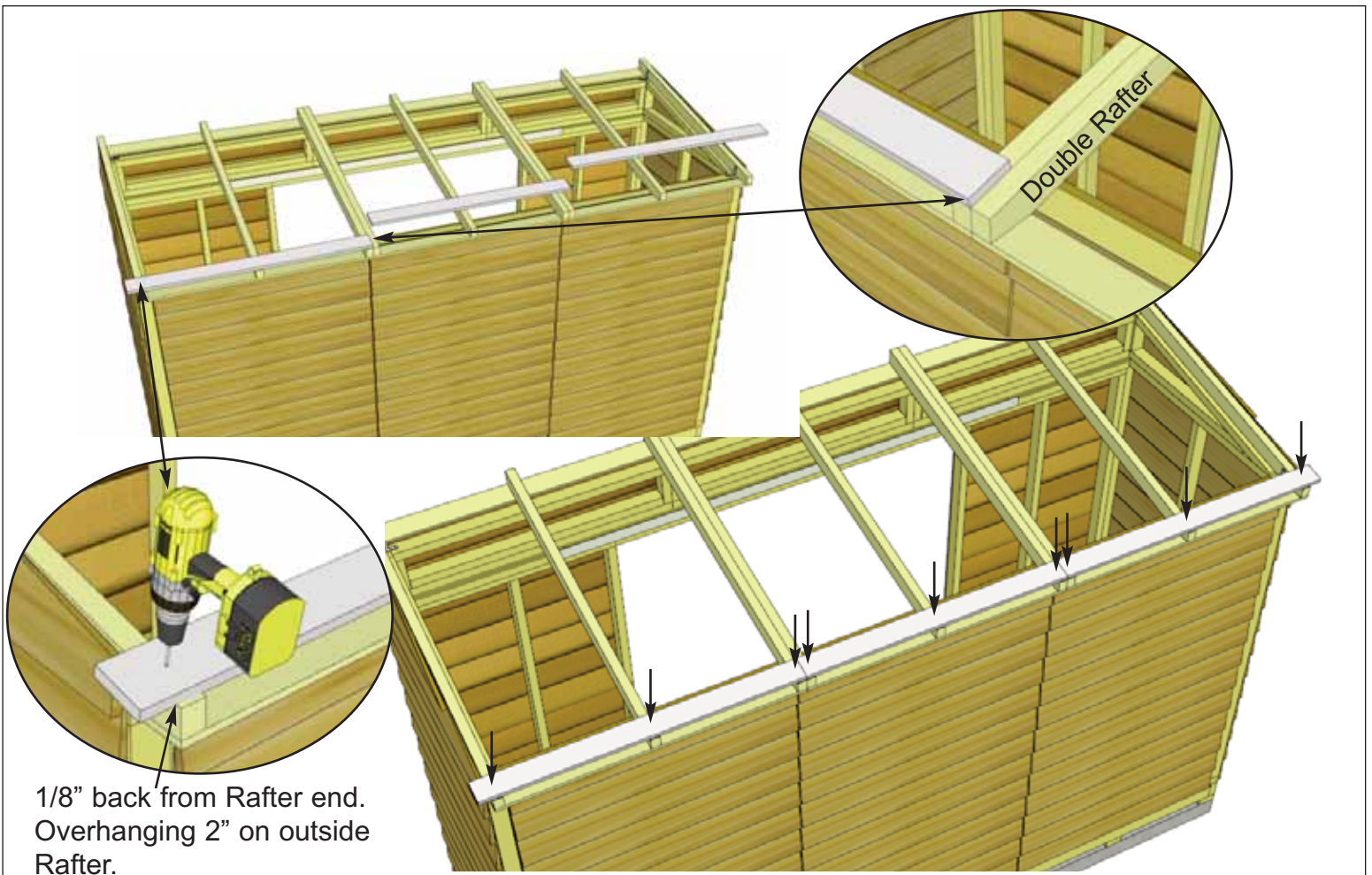

1/8" back from Rafter end.
Overhanging 2" on outside
Rafter.

32. Locate first row of **Roof Battens**. Position on rear of roof Rafters. Place 1/8" back from end of Rafter. Batten will sit evenly on center rafters overhanging 2" on the outside rafters. Attach Battens with **1 - 1 1/4" Screw** per each rafter. Pre-drill with 1/8" drill bit first to prevent end from splitting.

Parts (Steps 32 - 36)

3G - Roof Battens - Outer
(3/4" x 3 1/2" x 50") x 6

3H - Roof Battens - Center
(3/4" x 3 1/2" x 45 1/2") x 3

Parts (Steps 32 - 36)

3D - Batten Spacers
(3/4" x 1 1/2" x 21 5/8") x 4

Hardware (Steps 32 - 36)

S2 - 1 1/4" Screws
x 34 total

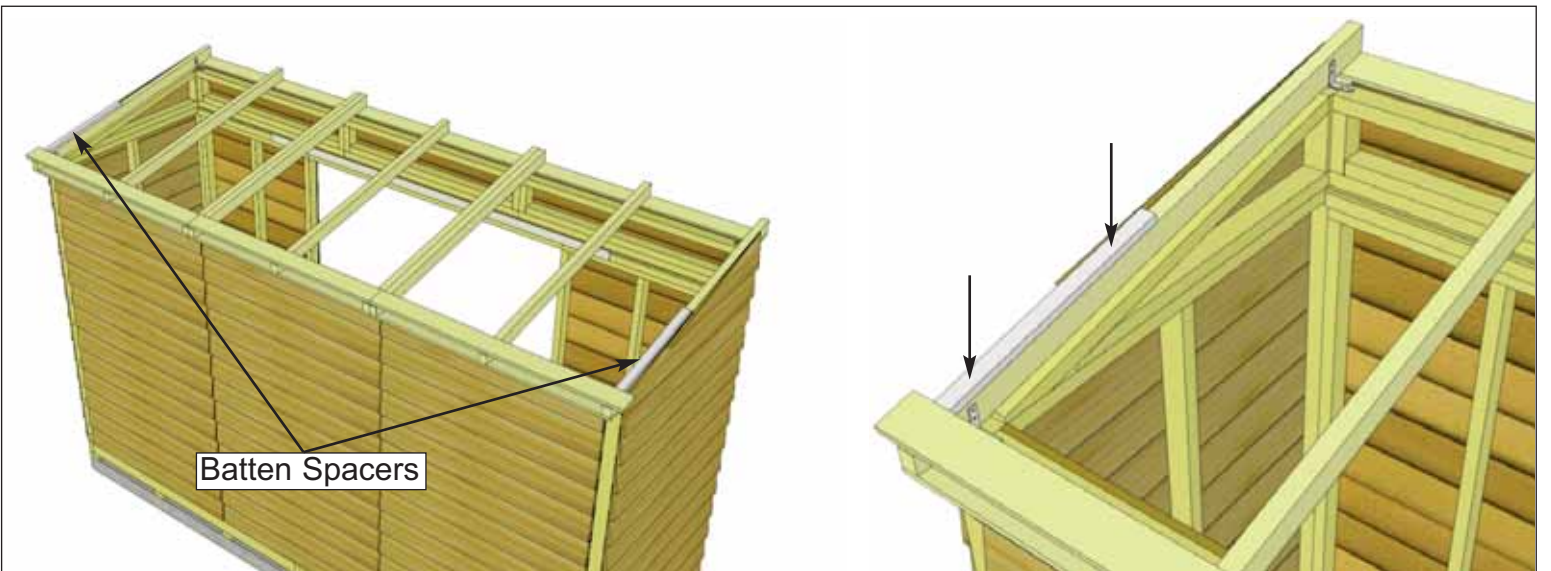

Batten Spacers

33. Locate **Batten Spacers**. Place one **Batten Spacer** above each Batten lengthwise along outside Rafter. Attach each Batten Spacer to outside Rafter with **2 - 1 1/4" screws** per Batten Spacer (4 total).

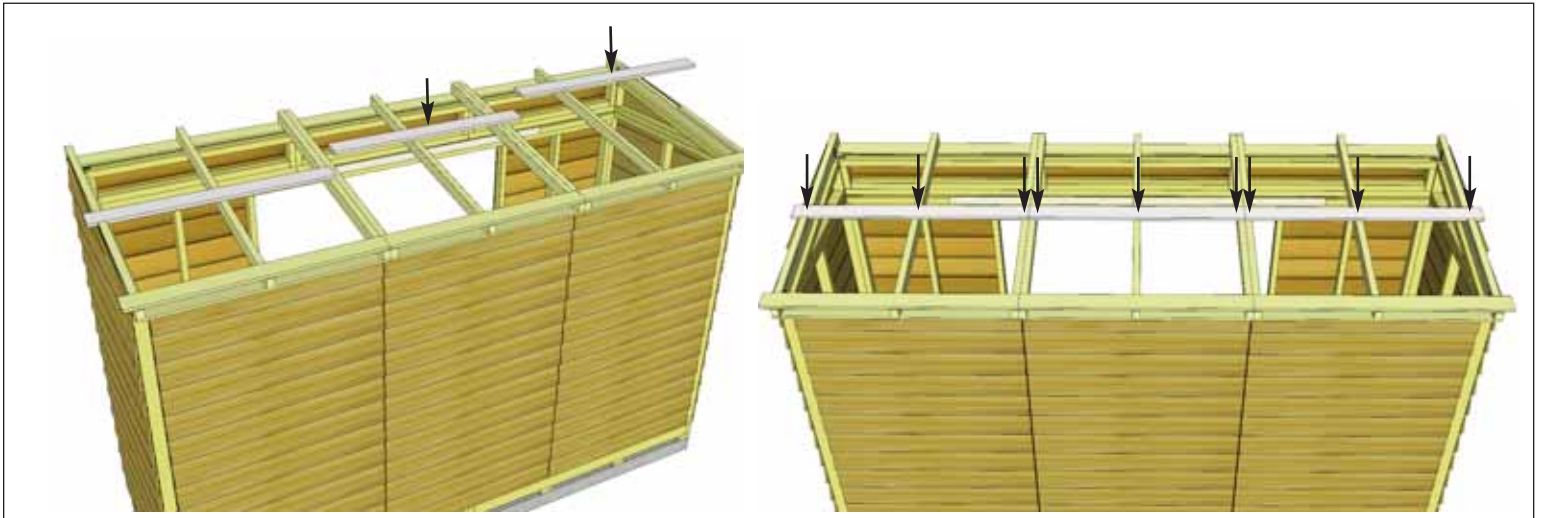

34. Position and attach 2nd row of **Battens** flush to **Batten Spacers** as per **Step 32**.

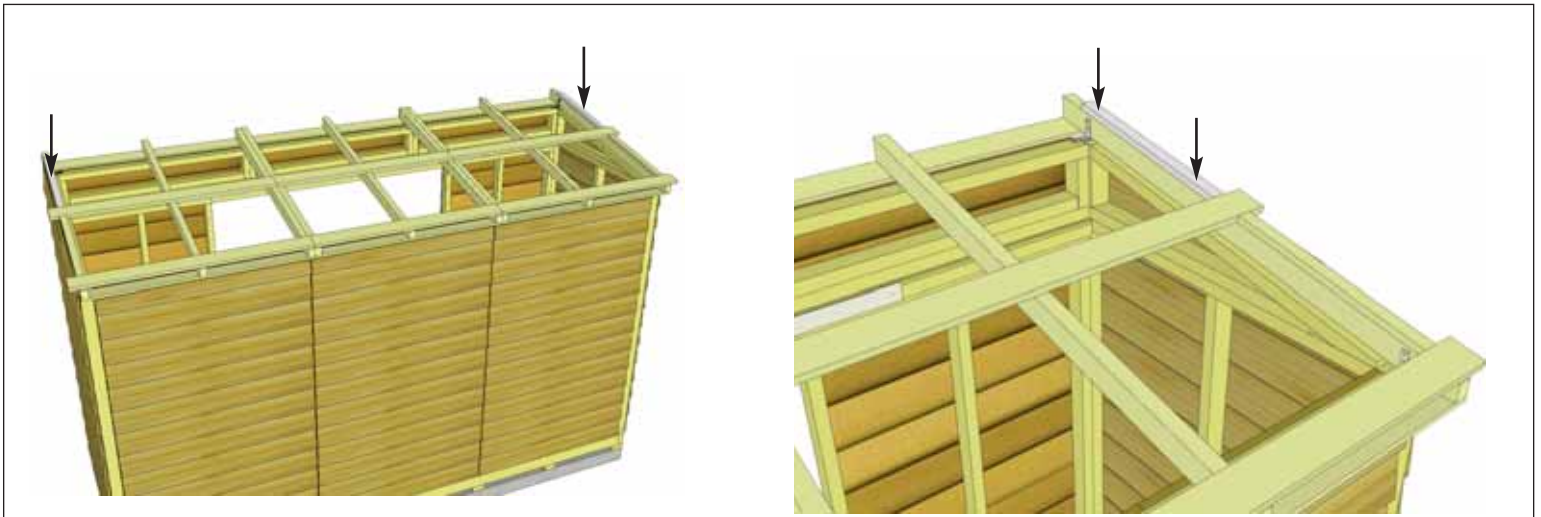

35. Position and attach 2 remaining **Batten Spacers** as per **Step 33** with 2 - 1 1/4" screws per spacer (4 total).

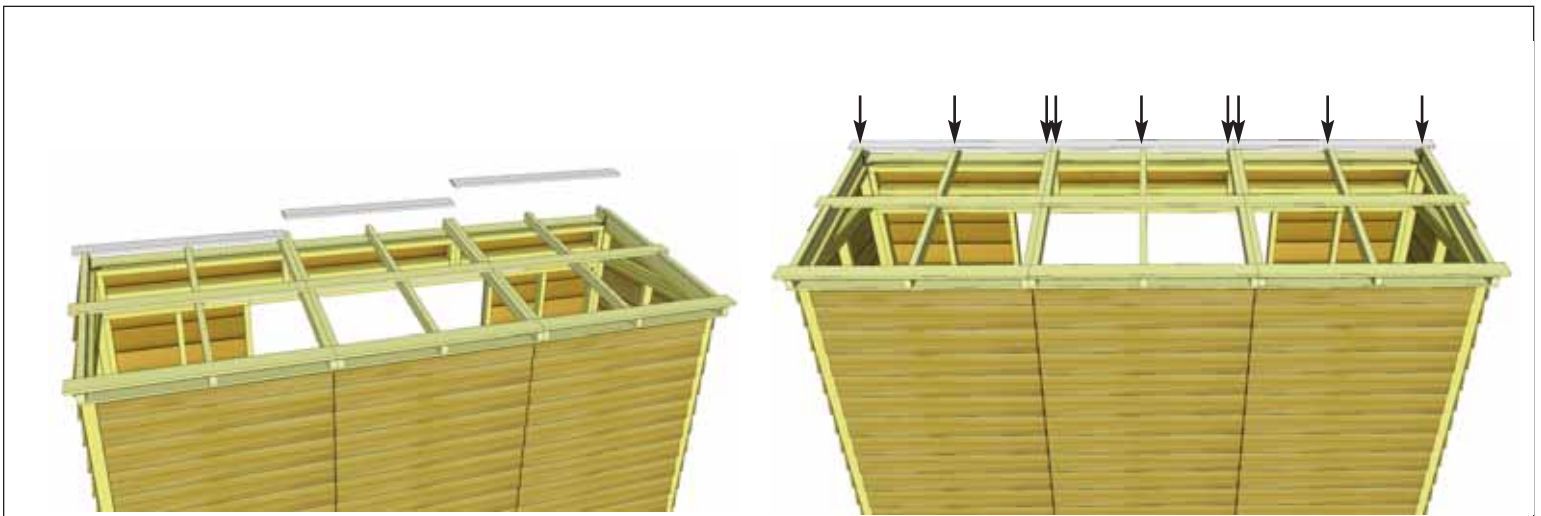

36. Position and attach 3rd row of **Battens** as per **Step 32**. Position Battens flush to **Batten Spacers** from **Step 35**.

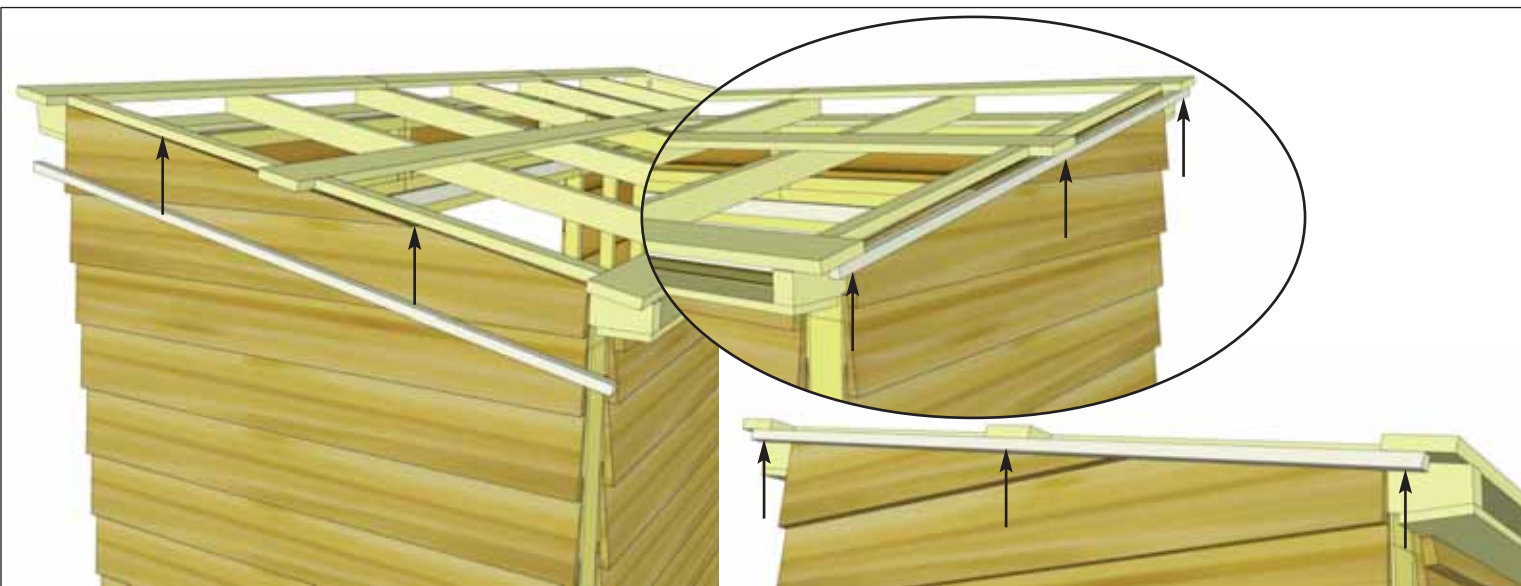

37. Center Facia Nailing Strip (underneath outside of each batten. Attach with **3 - 1 1/4" Screws** evenly spaced into the batten. The Facia Nailing Strip provides for a greater nailing surface later when you attach side facia.

Parts
3J - Nailing Strips
 (3/4" x 3/4" x 51") x 2

Hardware
S2 - 1 1/4" Screws
 x 6 total

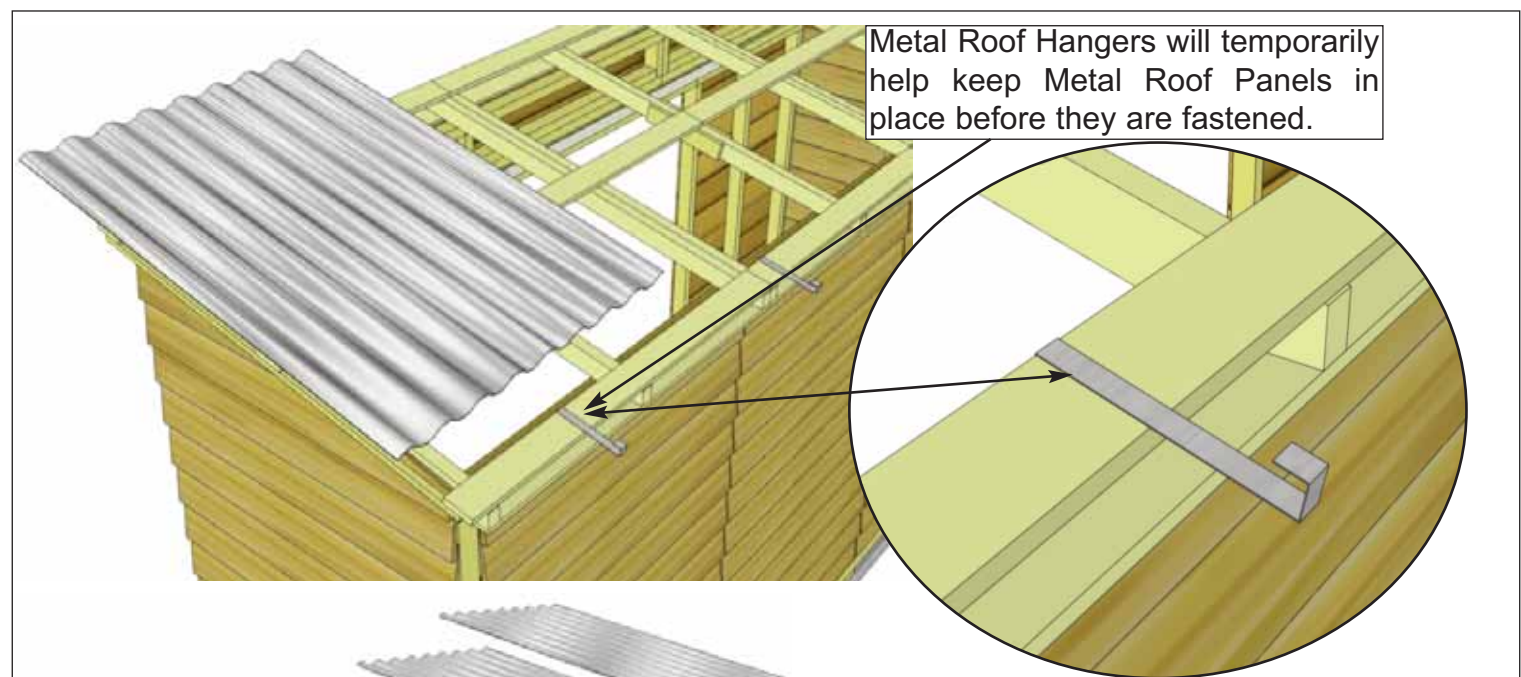

Metal Roof Hangers will temporarily help keep Metal Roof Panels in place before they are fastened.



38. Locate all **Metal Roof Hangers** and **Metal Roof Panels** (Identical). To temporarily help hold the **Metal Roof Panel** in place, hook a **Metal Roof Hanger** onto the lower **Batten** approximately where the center of the first **Panel** will be. Place the first **Metal Roof Panel** on **Battens**. Do not fasten **Panels** down until **Steps 42 & 44**. Place other two **Metal Roof Panels** with **Hangers** the same way.

Parts
3K - Metal Roof Panels
 (39" x 58 1/2") x 5

Hardware
Y38 - Metal Roof Hangers x 5 total

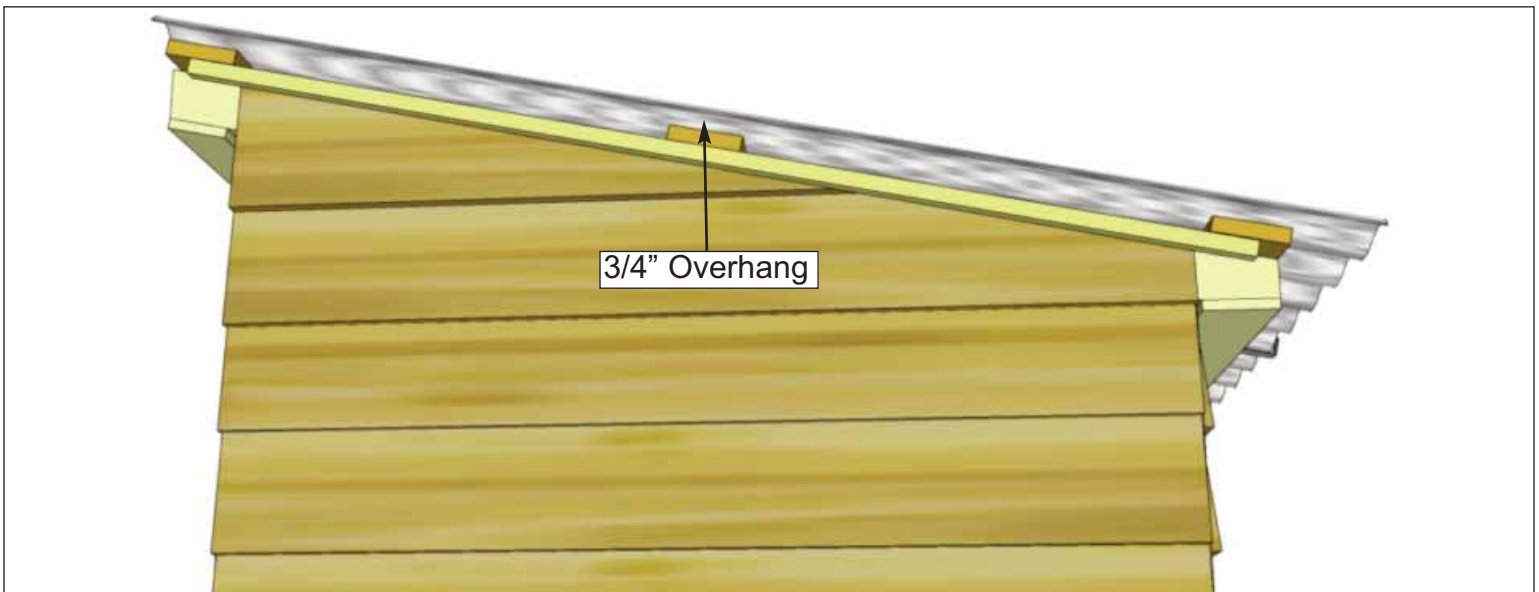

39. Overhang the **Metal Roof Panels** past the **Battens** on the sides by approximately 3/4". The overhang on front and back will be set by the **Metal Roof Hangers**, but should be approximately 1" on the front and approximately 4" on the back.

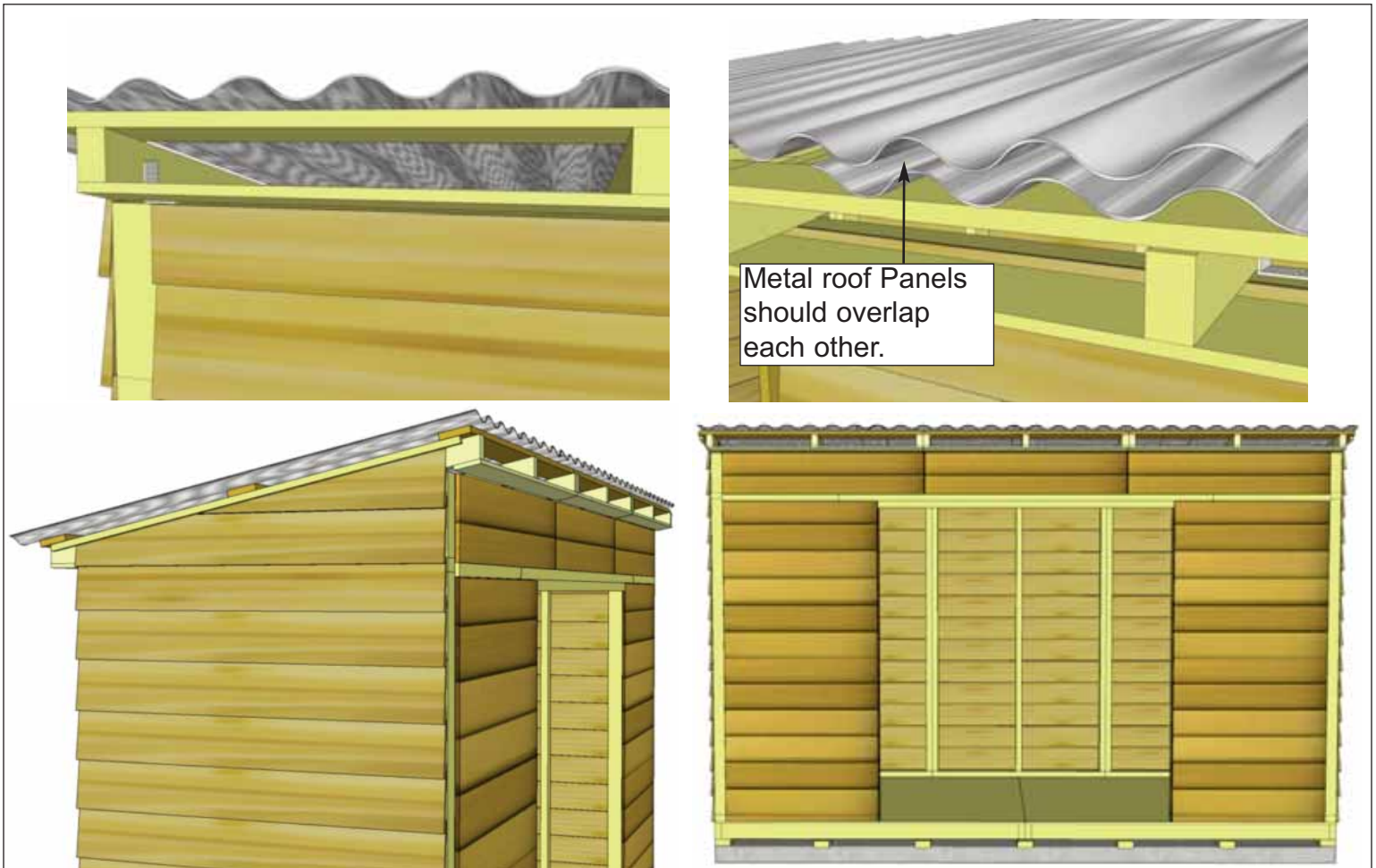

40. Adjust the position of remaining **Metal Roof Panels** on **Battens** as per **Step 39**. Overlap **Metal Roof Panels** to achieve the desired overall width. Overall width past the end of **Battens** can vary from 1" - 3", depending on your personal preference.

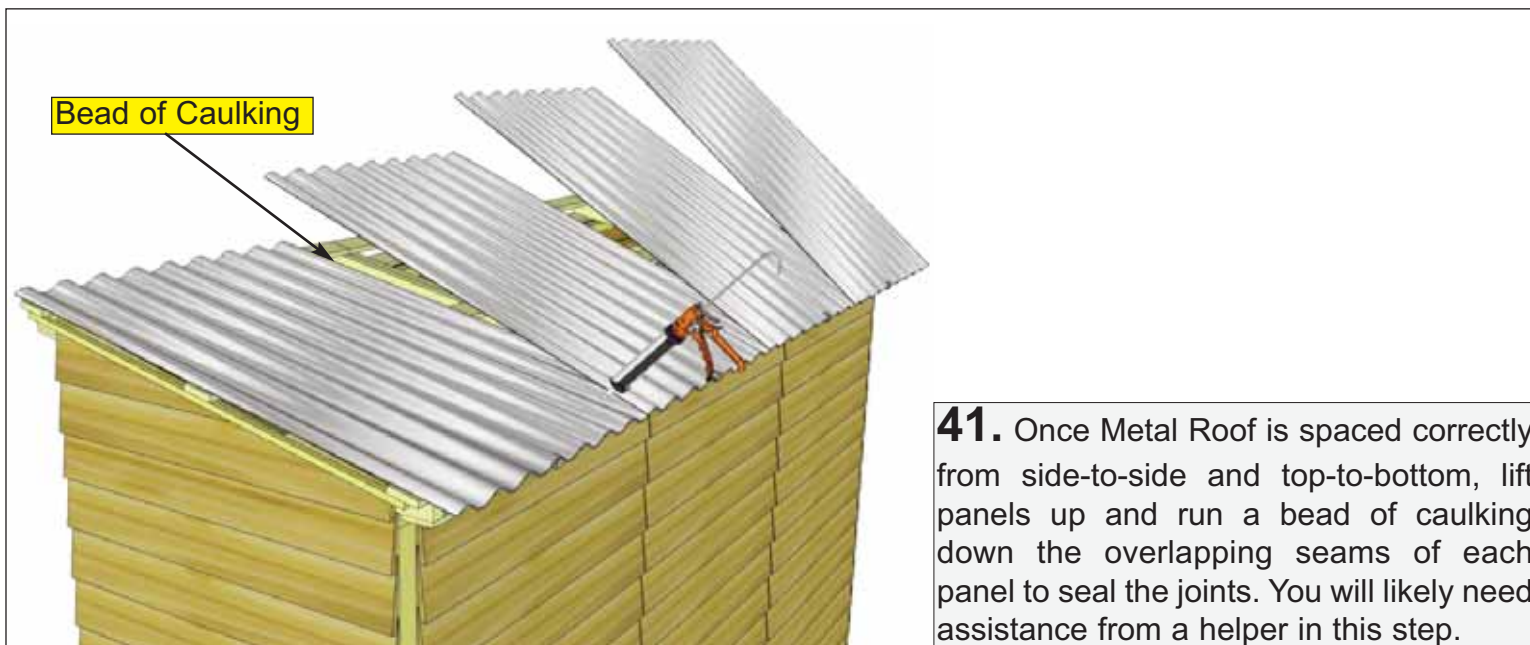

41. Once Metal Roof is spaced correctly from side-to-side and top-to-bottom, lift panels up and run a bead of caulking down the overlapping seams of each panel to seal the joints. You will likely need assistance from a helper in this step.

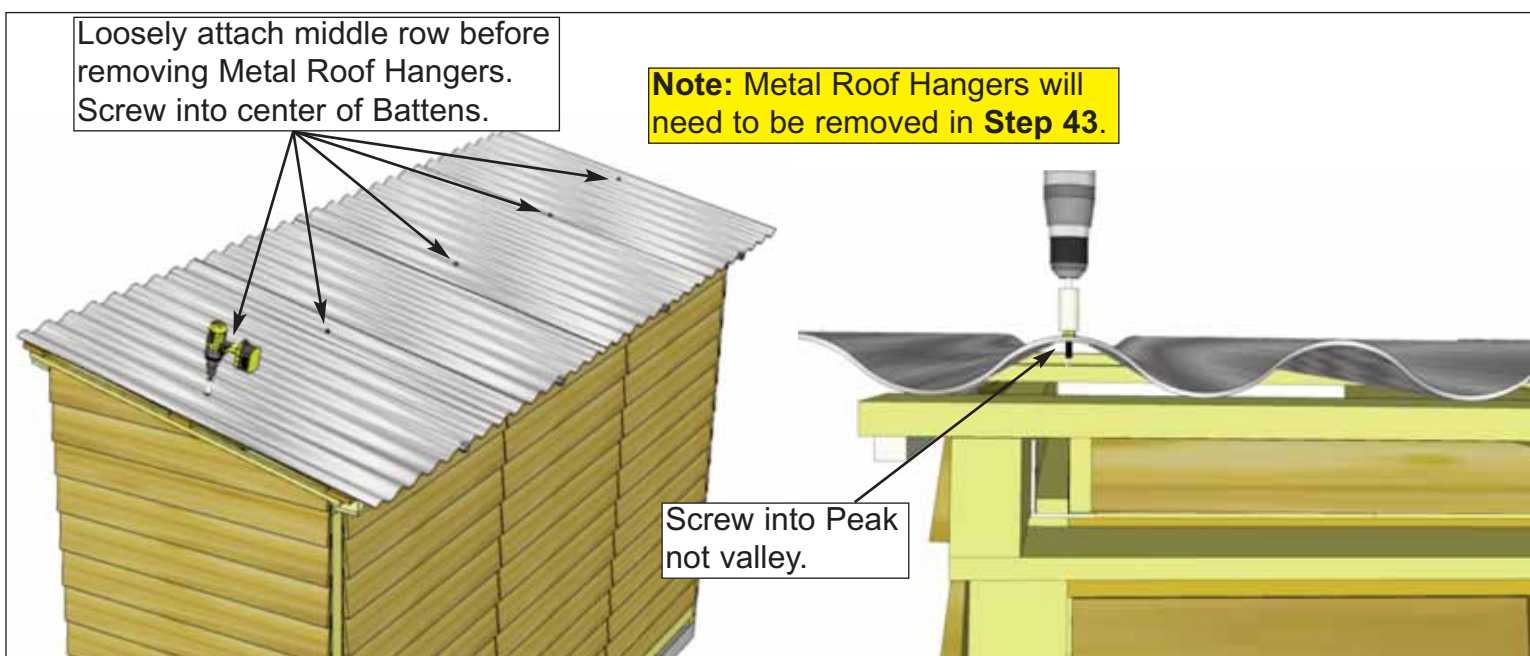

42. Using 5 - 2" Metal Screws and 1/4" Nut Driver (included), partially secure Metal Roof Panels down to the middle Batten row. Only fasten screws half way so the Metal Roof Hangers can be removed. Metal screw is self-tapping, screw into the center of Battens. Ten more 2" Metal Screws will be required to further secure Metal Roof Panels and to complete Metal Drip Caps in later steps.

Hardware
2" Metal Roof Screws
 x 5 total

Remove Metal Roof Hangers

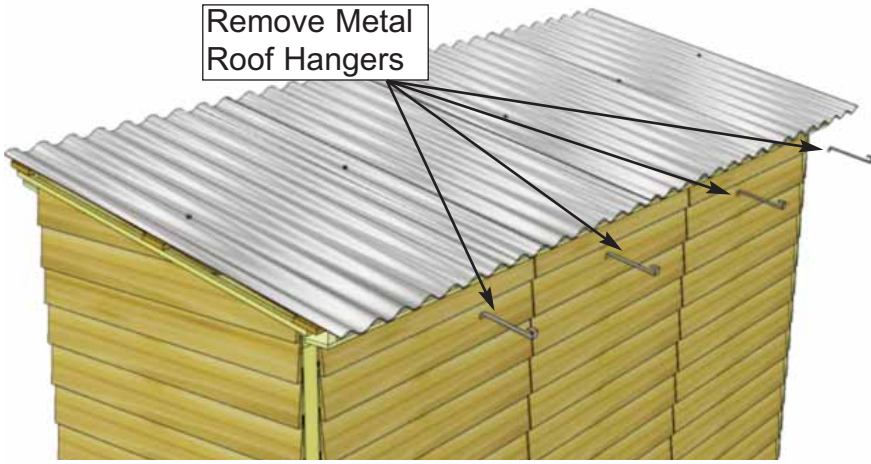

43. Before fully fastening **Metal Roof Panels** down, remove the **Metal Roof Hangers** and insert **Foam Enclosures** between **Metal Roof Panels** and **Battens** at the rear/bottom. Enclosures will prevent moisture and unwanted bugs, etc from entering your shed from here.

Parts

Foam Enclosures x 4 total



Insert Foam Enclosures

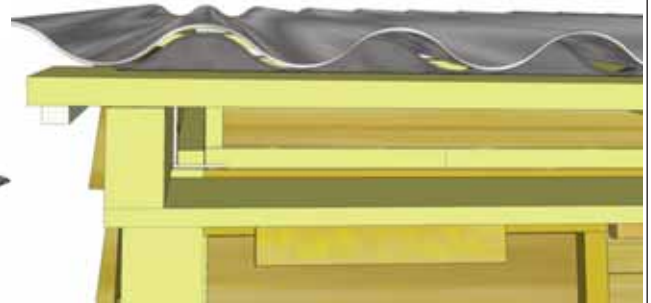

Secure lower/front Batten row, be careful not to overtighten.

Tighten middle row, be careful not to overtighten.

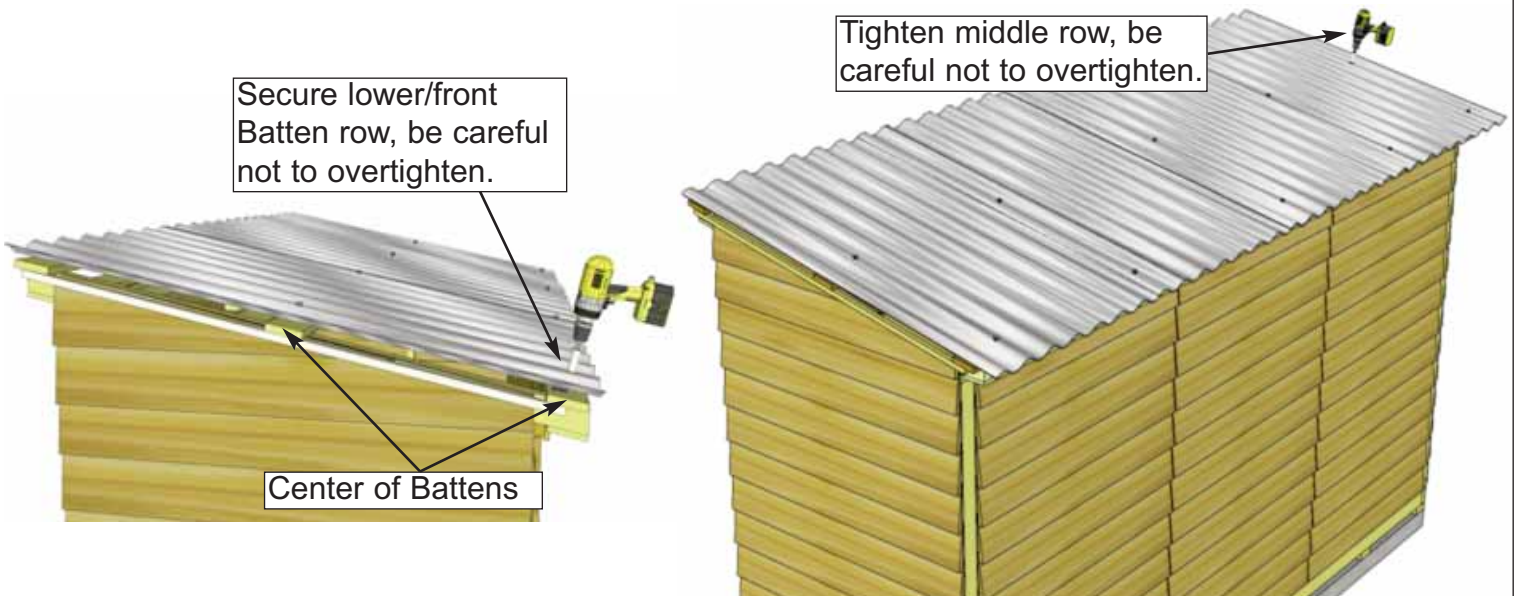

Center of Battens

44. Using **5 - 2" Metal Screws** and **1/4" Nut Driver**, secure **Metal Roof Panels** down to lower/rear **Batten** row. Tighten screws in middle **Batten** row which were partially attached in **Step 42**. Do not overtighten!

Hardware

2" Metal Roof Screws
x 5 total

Note: If Top Siding Pc. for Angle Wall was not installed in Step 16 it can be done now. Attach with 3 - 1 1/2" Finishing Nails per piece.

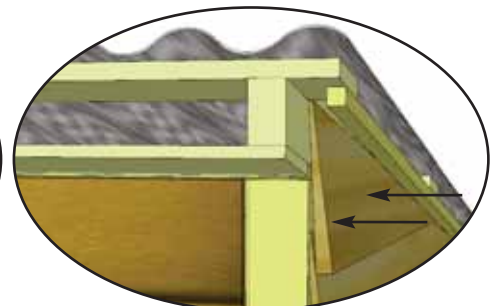
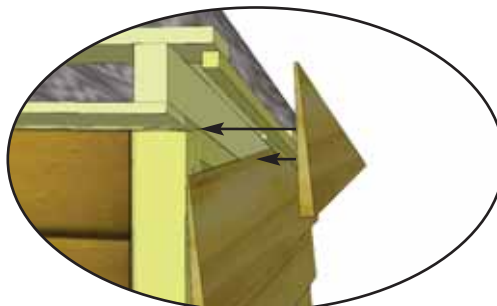

4. Trim & Miscellaneous Section

Exploded view of all parts necessary to complete the Skirting, Trim, Facia and Miscellaneous Pieces. Identify all parts prior to starting.

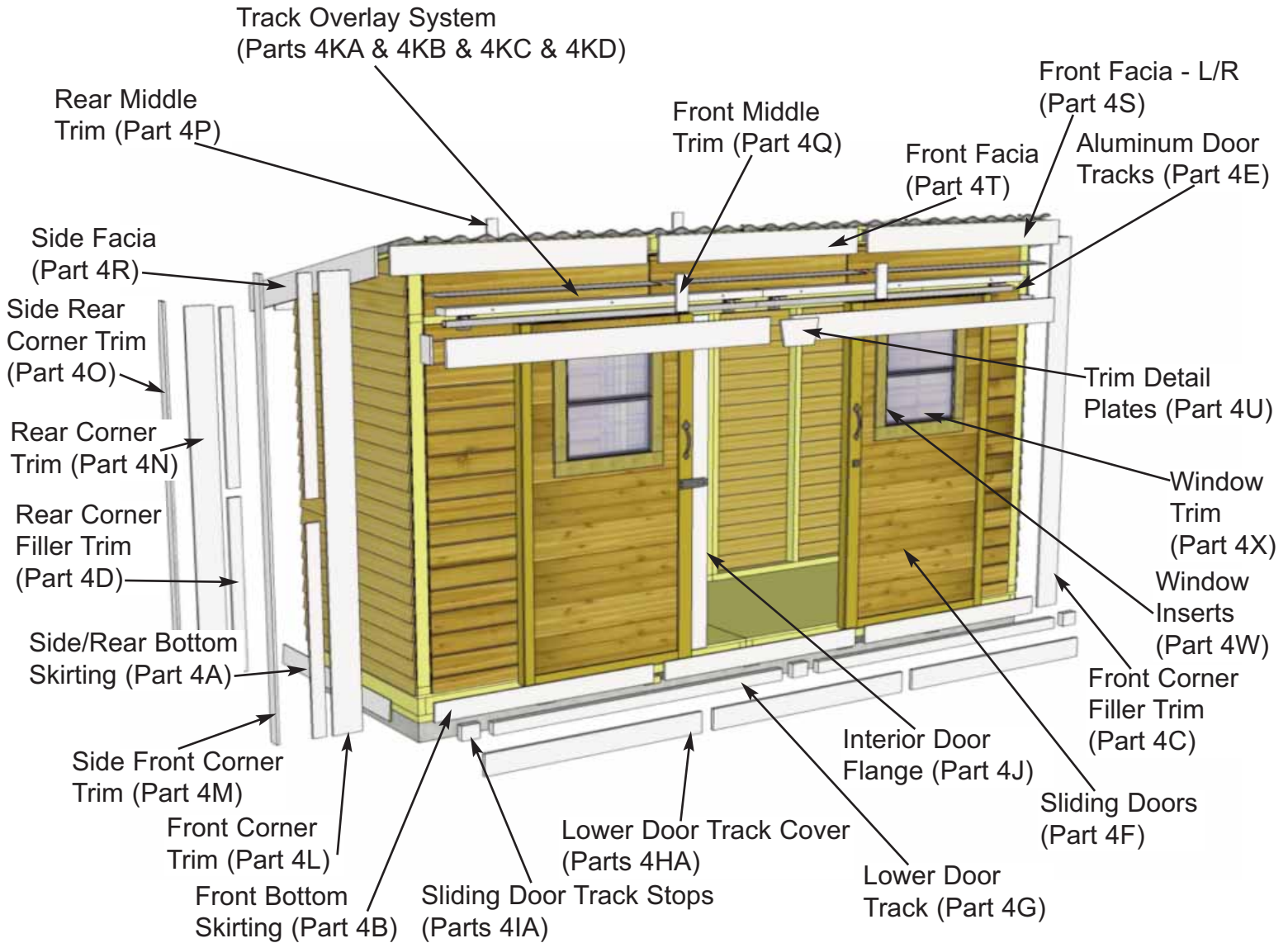

Note: All Trim, Facia, and Bottom Skirting pieces will be positioned rough face out when installed.

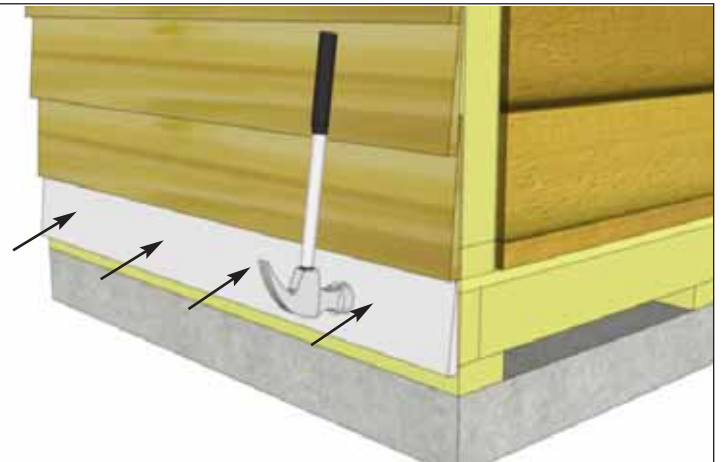
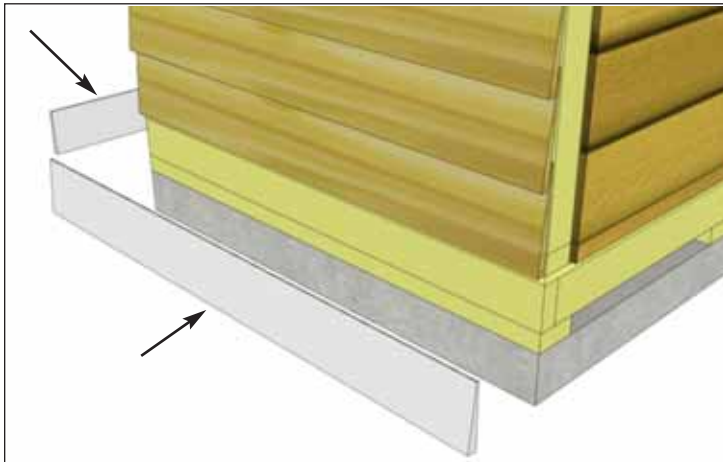

45. Attach **4A - Side/Rear Bottom Skirting** around the base of the shed. Skirting will hide floor framing. Start with side skirting pieces first and attach with **4 - 1 1/2" Finishing Nails** per piece.

<u>Parts (Steps 45 - 46)</u>	
4A - Side/Rear Bottom Skirting - FJ (1/2" x 4 1/2" x 45 1/4") x 5	
<u>Hardware (Steps 45 - 46)</u>	
N1 - 1 1/2" Finishing Nails x 20 total	

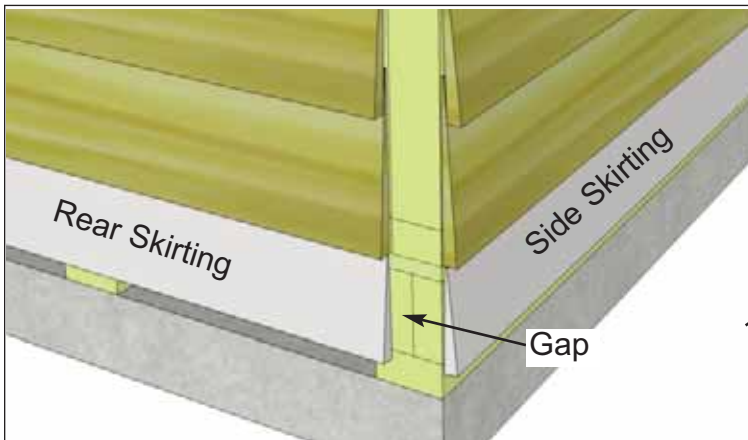

46. Gaps on outside will be covered by Corner Trim later. Complete side and rear skirting attachments.

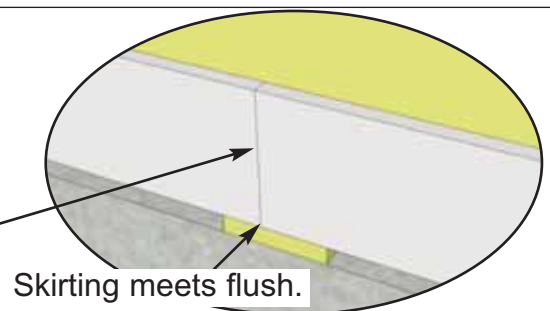
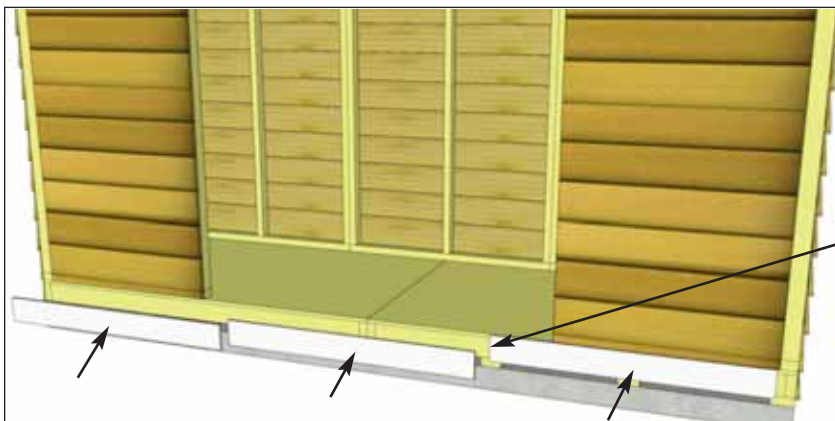

47. Attach **4B - Front Bottom Skirting** with **4 - 1 1/2" Finishing Nails** per piece as per **Steps 43 - 44.**

<u>Parts</u>
4B - Front Bottom Skirting (1/2" x 4" x 45 1/4") x 3

<u>Hardware</u>
N1 - 1 1/2" Finishing Nails x 12 total

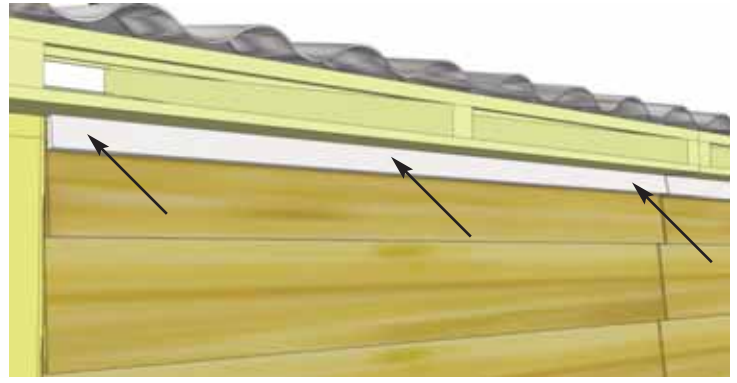

48. Trim out Rear Walls by attaching **Top Wall Trim**. Position with thick end of Bevel downward at top wall, tight against Soffits. Attach with **4 - 1 1/2" Finishing Nails** per piece.

<u>Parts</u>
4BB - Top Wall Trims (3/4" x 1 1/2" x 45 1/4") x 3
<u>Hardware</u>
N1 - 1 1/2" Finishing Nails x 12 total

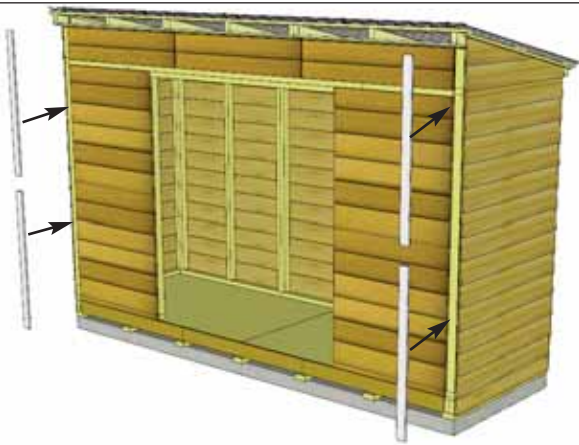

49. Position and attach **4C - Front Corner Filler Trim** with **4 - 1 1/2" Finishing Nails** per piece. Filler trims won't be visible because they serve as nailing strips for the Corner Trims which will be attached later.

<u>Parts</u>
4C - Front Corner Filler Trim (1/2" x 2 1/2" x 42") x 4
<u>Hardware</u>
N1 - 1 1/2" Finishing Nails x 16 total



50. Position and attach **4D - Rear Corner Filler Trim** with **4 - 1 1/2" Finishing Nails** per piece as per **Step 49**.

<u>Parts</u>	<u>Hardware</u>
4D - Rear Corner Filler Trim (3/4" x 2 1/2" x 38") x 4	N1 - 1 1/2" Finishing Nails x 16 total

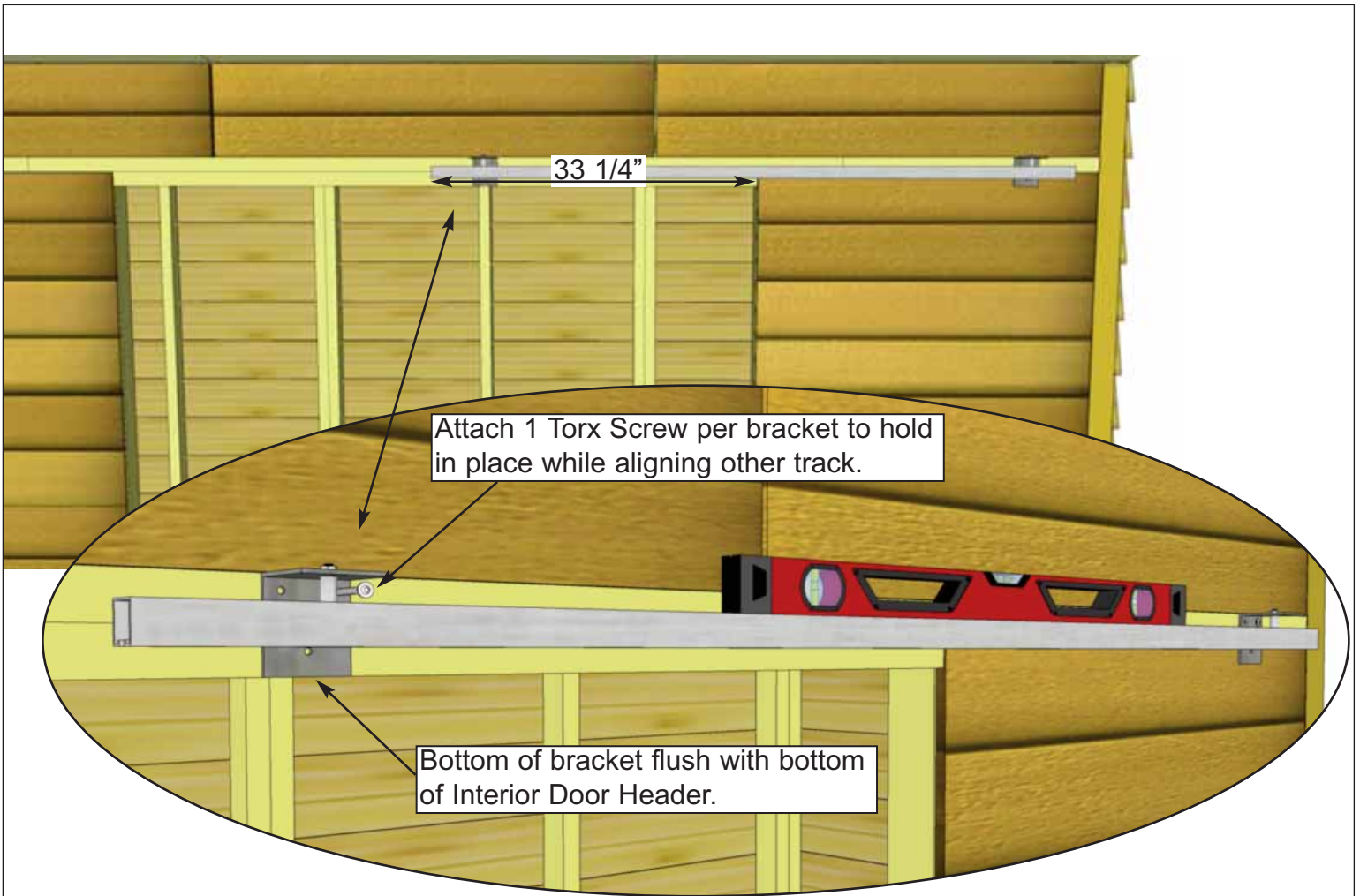

51. Position **4E - Aluminum Door Tracks** so they meet in the center of the doorway and with the pre-installed brackets fitting evenly on Door Headers. Ensure Track is level and attach with **1 - 1 1/2" Torx Screw** per bracket to hold in place while aligning other Track.

Position second Track the same and attach with **3 - 1 1/2" Torx Screws** per bracket. Complete remaining Torx Screws on brackets of first Track.

Parts
4E - Aluminum Door Tracks
 x 2

Hardware
ST1 - 1 1/2" Torx Screws
 x 12 total

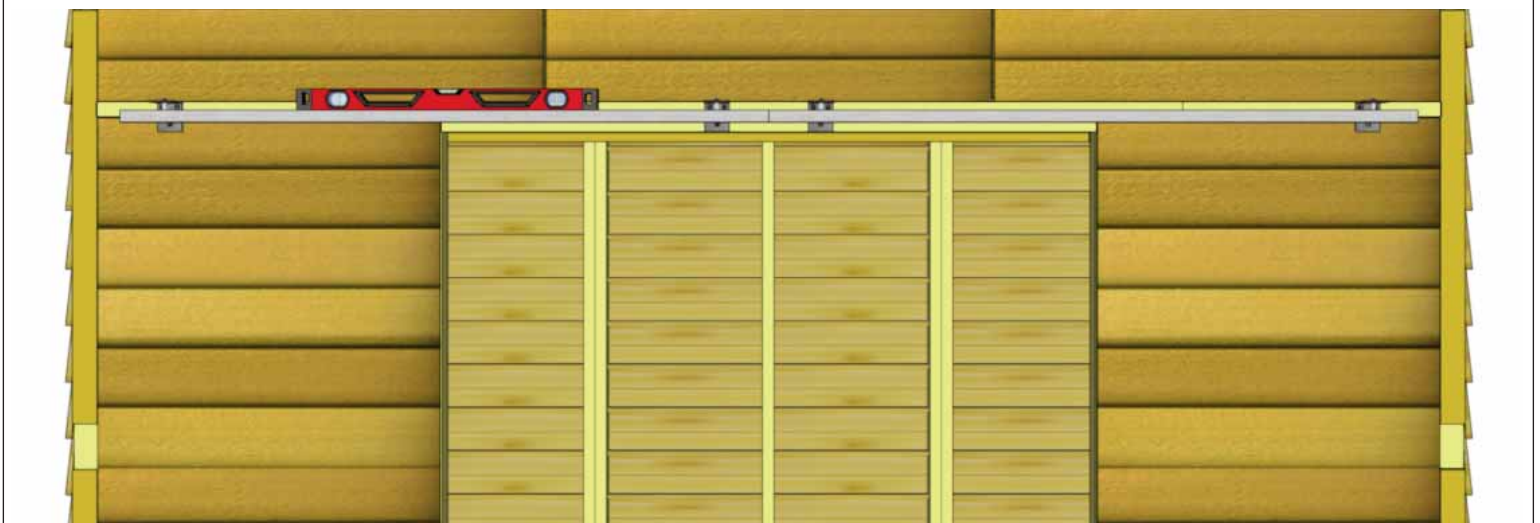

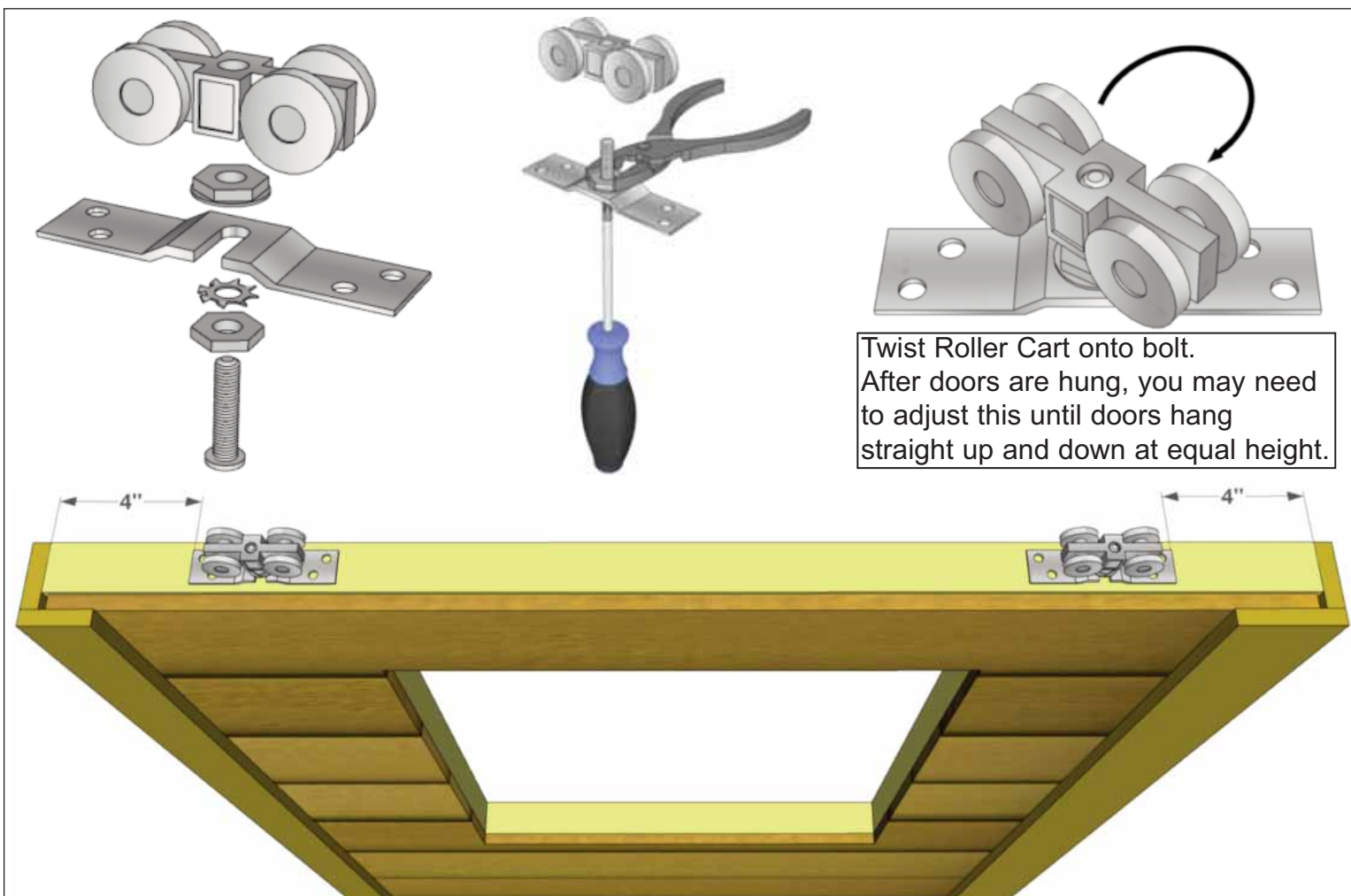

Twist Roller Cart onto bolt.
After doors are hung, you may need to adjust this until doors hang straight up and down at equal height.

52. Locate all four **Y35 - Roller Assemblies**. Before attaching to top of doors, assemble the units as shown above. Attach two Roller Assemblies to each door with **4 - 1 1/4" Screws** per Assembly, center on the door framing 4" from each end as shown above. Next, take Left Side Door and slide Rollers into the Aluminum Door Track. Repeat with Right Side Door and slide until doors meet in the middle.

<u>Parts</u> 4F - Sliding Doors (36" x 73") x 2
<u>Hardware</u> S2 - 1 1/4" Screws x 16 total Y35 - Roller Assembly x 4 total

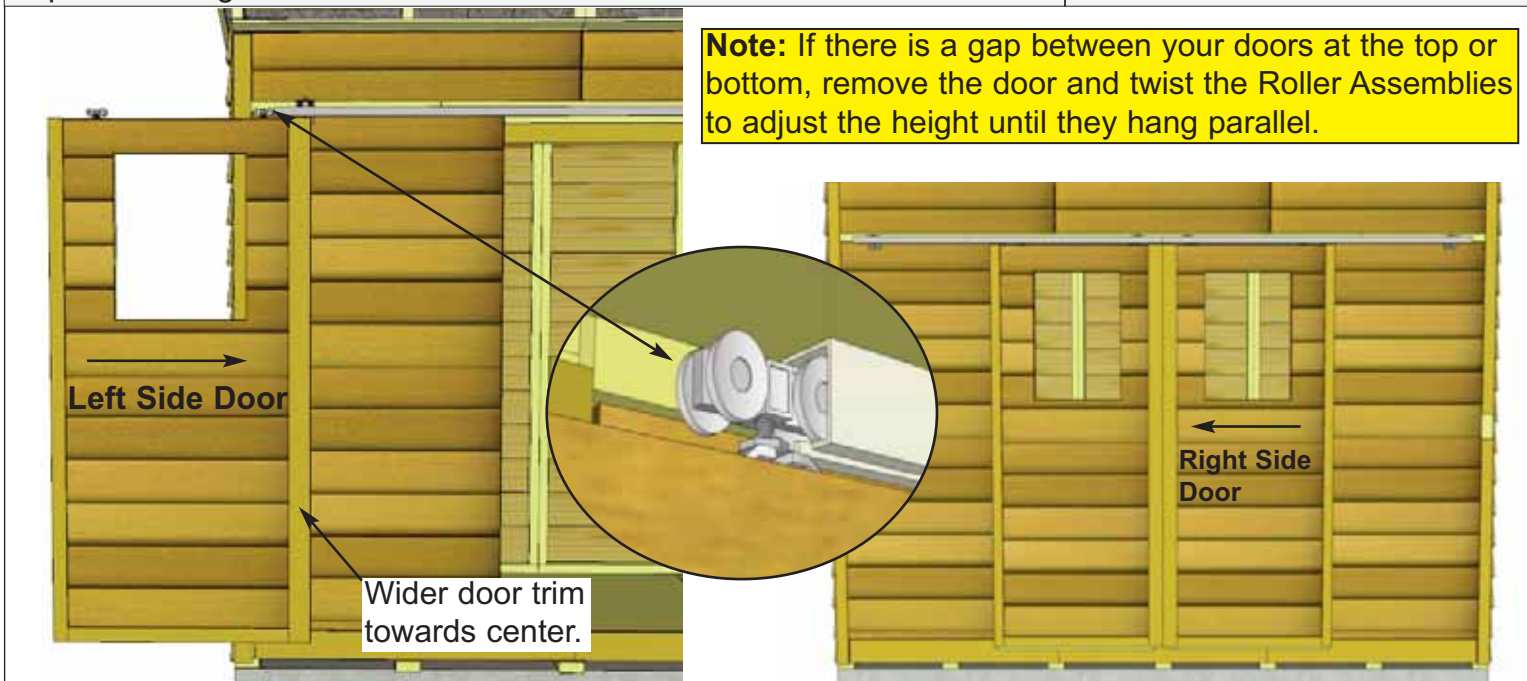

Note: If there is a gap between your doors at the top or bottom, remove the door and twist the Roller Assemblies to adjust the height until they hang parallel.

Wider door trim towards center.

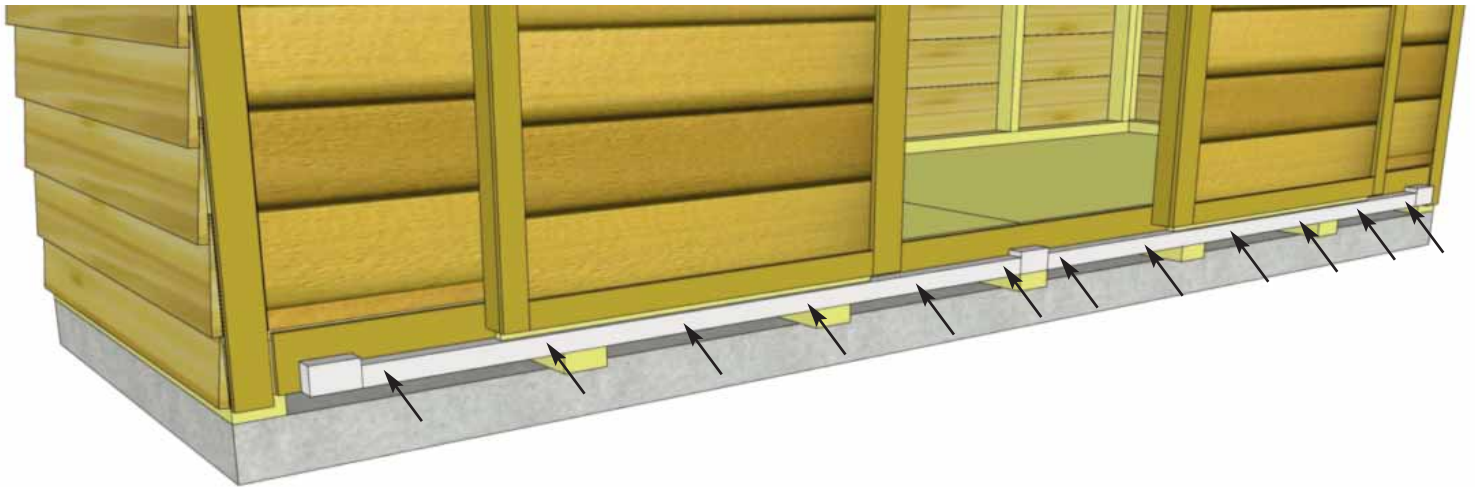
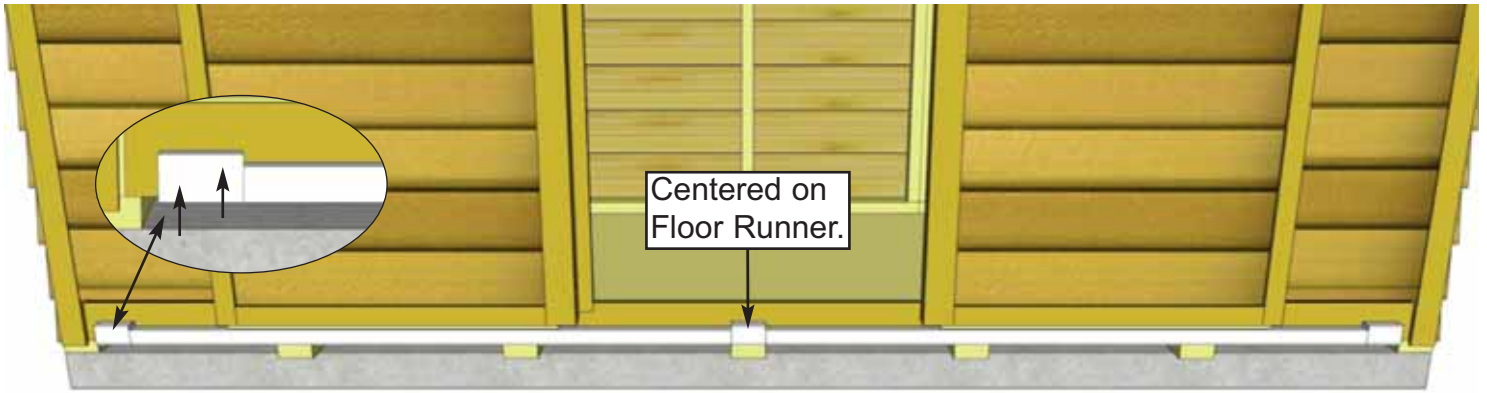
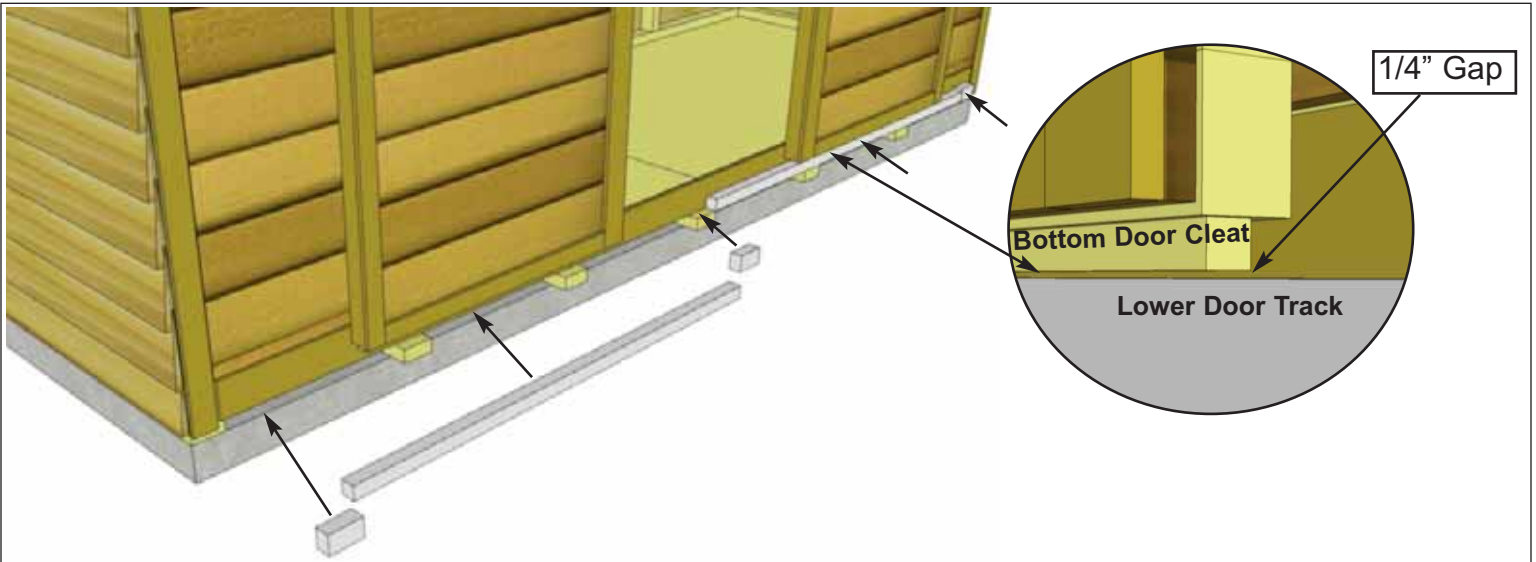

53. Locate **4G - Door Tracks** and **4IA - Door Stops**. Start with Middle Door Stop centered on middle Floor Runner and build out from there. Door Tracks rest on Long Floor Runners. Bottom of Door Stops and Door Tracks should be flush with each other. Secure Door Tracks to shed with **6 - 3" screws** per piece. Secure Door Stops with **2 - 3" screws** per piece.

<u>Parts</u>
4G - Lower Door Track (1 1/2" x 1 1/2" x 61 1/8") x 2
4IA - Door Track Stops (1 1/2" x 2" x 3 1/2") x 3
<u>Hardware</u>
S4 - 3" Screws x 18 total

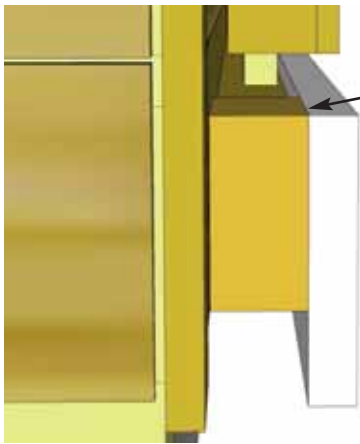
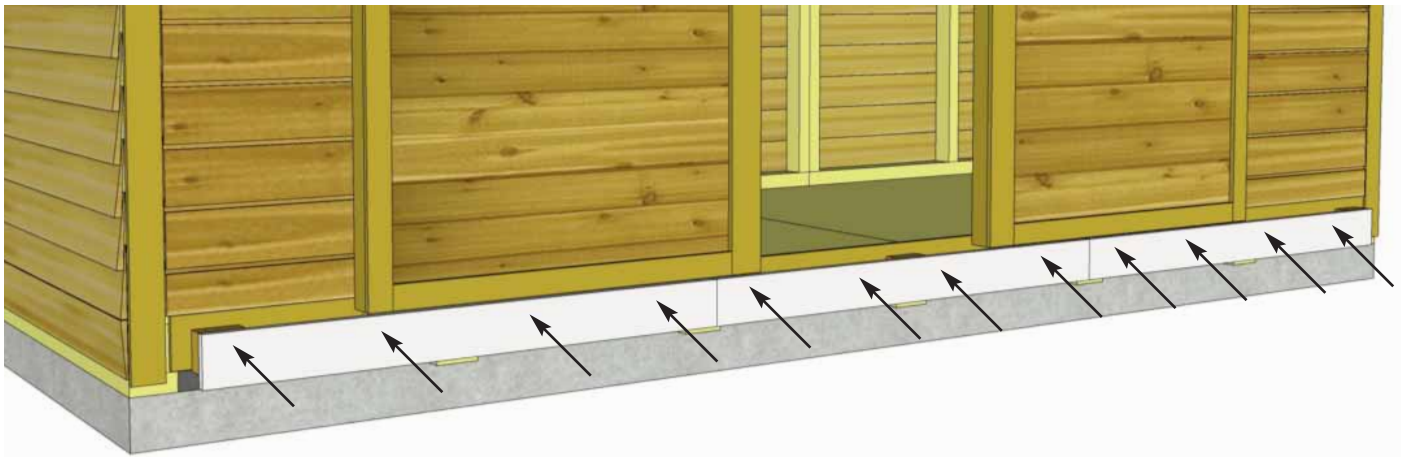

Door Stop and Track Cover are flush



54. Locate **4HA - Door Track Covers**. Lineup so Track Covers are flush with Door Stops. This creates an enclosure so doors can not slide out of the track. Secure each piece of Track Cover with **4 - 2 1/2" screws**.

Parts
4HA - Lower Door Track Cover
 (3/4" x 3" x 44 1/4") x 3

Hardware
S1 - 2 1/2" Screws
 x 12 total

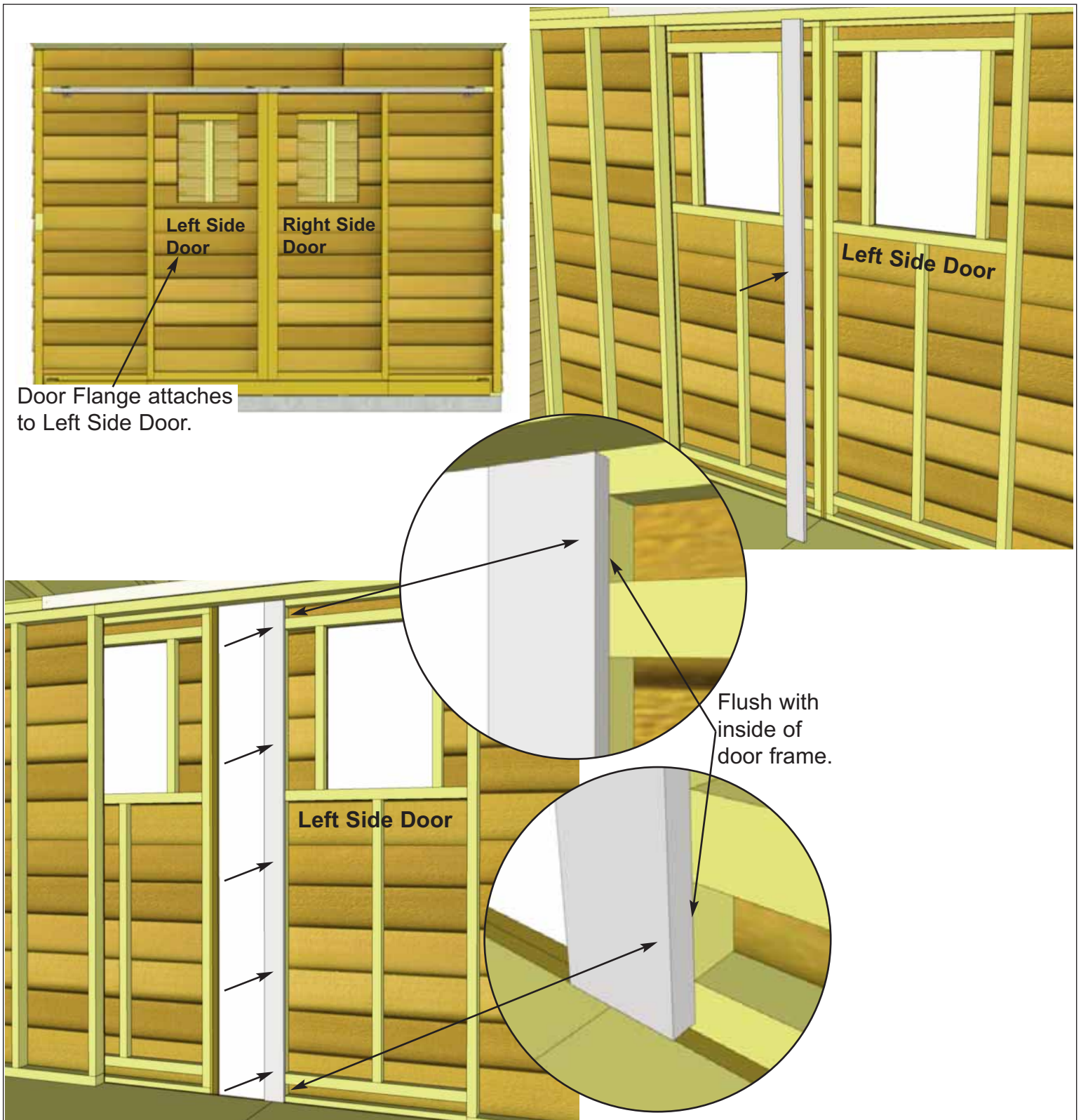

Door Flange attaches to Left Side Door.

Flush with inside of door frame.

55. Position **4J - Interior Door Flange** on the rear of the left side door (when viewed from the front of the shed). Ensure flange is flush with the inside of the door frame and attach with **5 - 1 1/4" Screws**.

<u>Parts</u>
4J - Interior Door Flange (3/4" x 3 1/2" x 71 1/2") x 1
<u>Hardware</u>
S2 - 1 1/4" Screws x 5 total

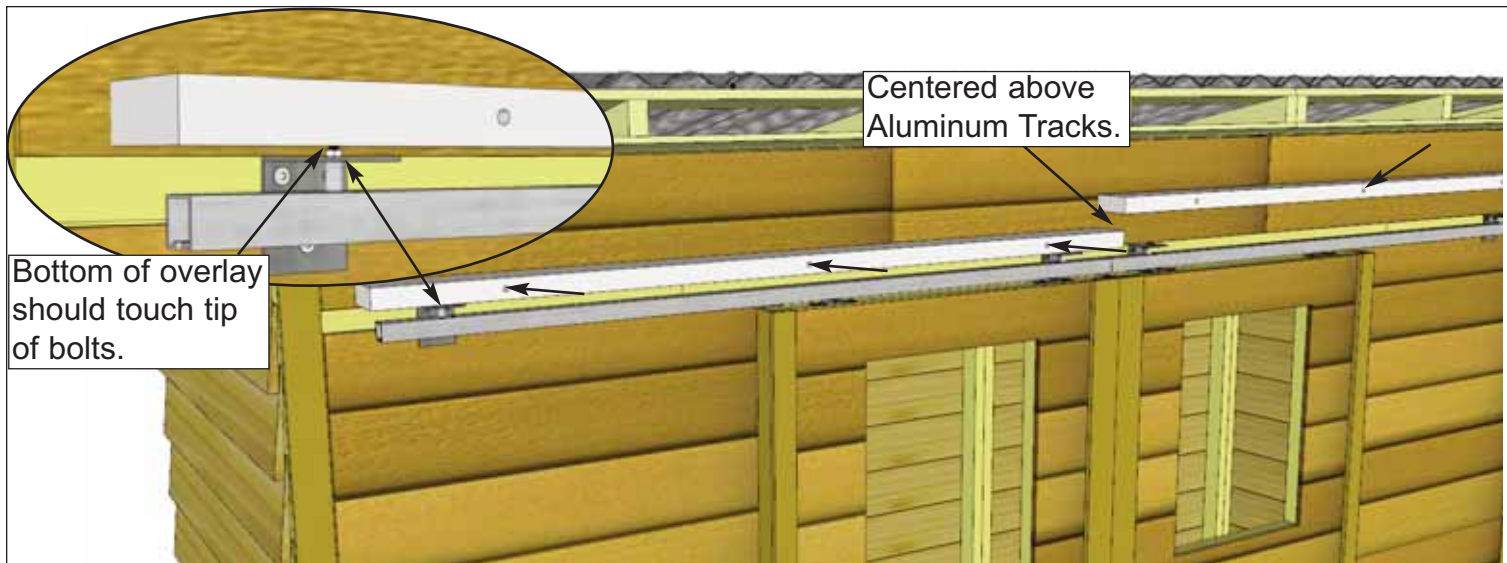

56. Install both **4KA - Track Overlay - Top** pieces above the aluminum tracks. Position pieces horizontally as shown above. Attach with **3 - 4" Screws** per piece through the pre-drilled holes.

Parts (Steps 56 - 57)
4KA - Track Overlay - Top
 (1 1/2" x 3 1/2" x 66 1/2") x 2
4KB - Track Overlay - Front
 (3/4" x 5 1/2" x 67") x 2
4KC - Track Overlay - Ends
 (1/2" x 3 1/2" x 5 1/2") x 2

Hardware (Steps 56-57)
S5 - 4" Screws
 x 6 total
N1 - 1 1/2" Finishing Nails
 x 24 total

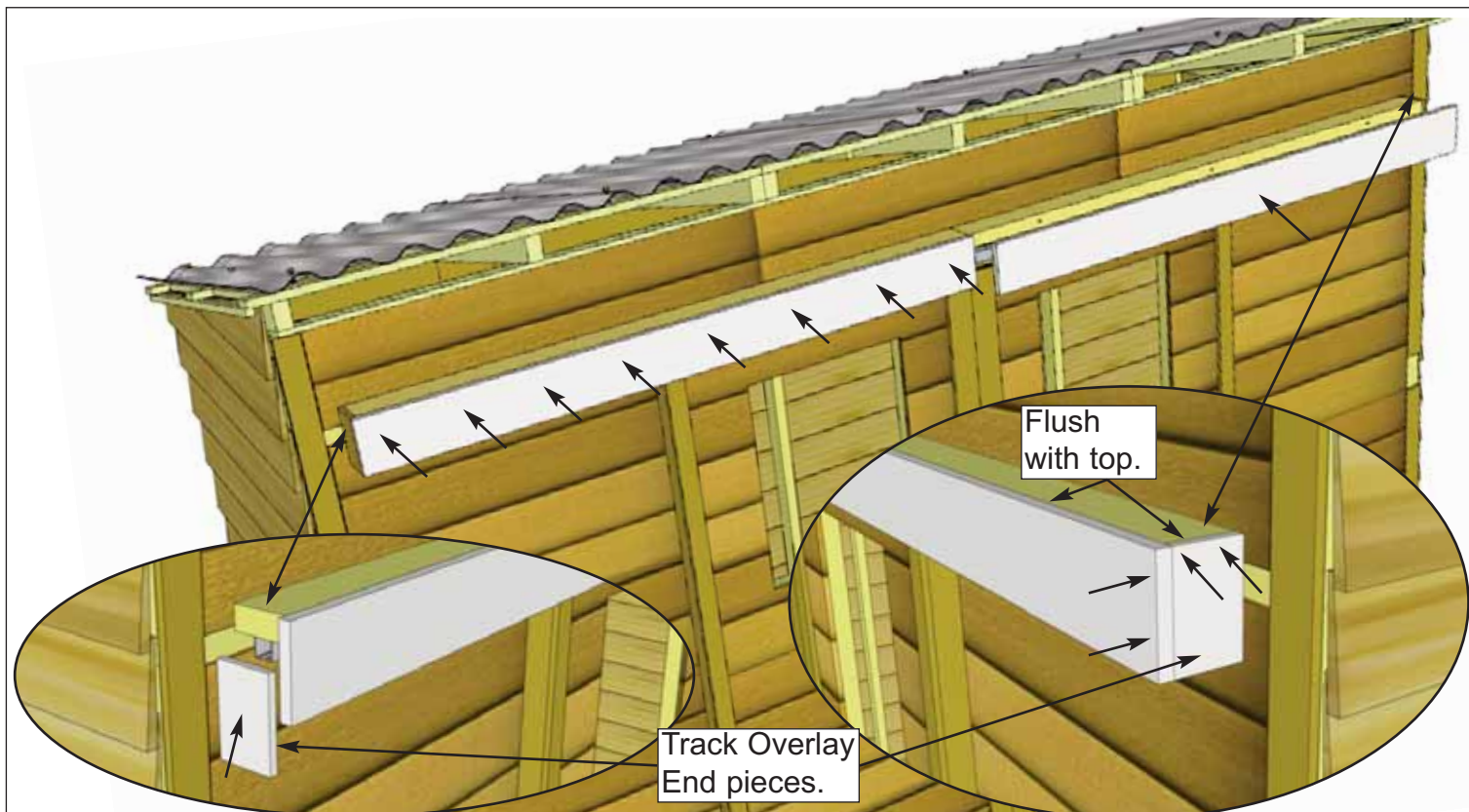

57. Position both of **4KB - Track Overlay - Front** onto the edge of the Overlay Top so they meet at the center. Ends of the Overlay Front will protrude 1/2" past the ends of the Overlay Top. Attach with **8 - 1 1/2" Finishing Nails** per piece. Next, attach **4KC - Track Overlay - Ends** as shown above with **4 - 1 1/2" Finishing Nails** per piece.



58. Position **4KD - Track Overlay - Sill** pieces evenly on top of Track Overlay with the slope facing away from the shed. This will prevent rainwater from collecting on top. Attach with **3 - 1 1/2" Finishing Nails** per piece. Hammer carefully and support the Track Overlay from below if necessary to avoid knocking it loose.

<u>Parts</u>
4KD - Track Overlay - Sill (Bevel) (1/2" x 4 1/4" x 44 1/4") x 3
<u>Hardware</u>
N1 - 1 1/2" Finishing Nails x 9 total

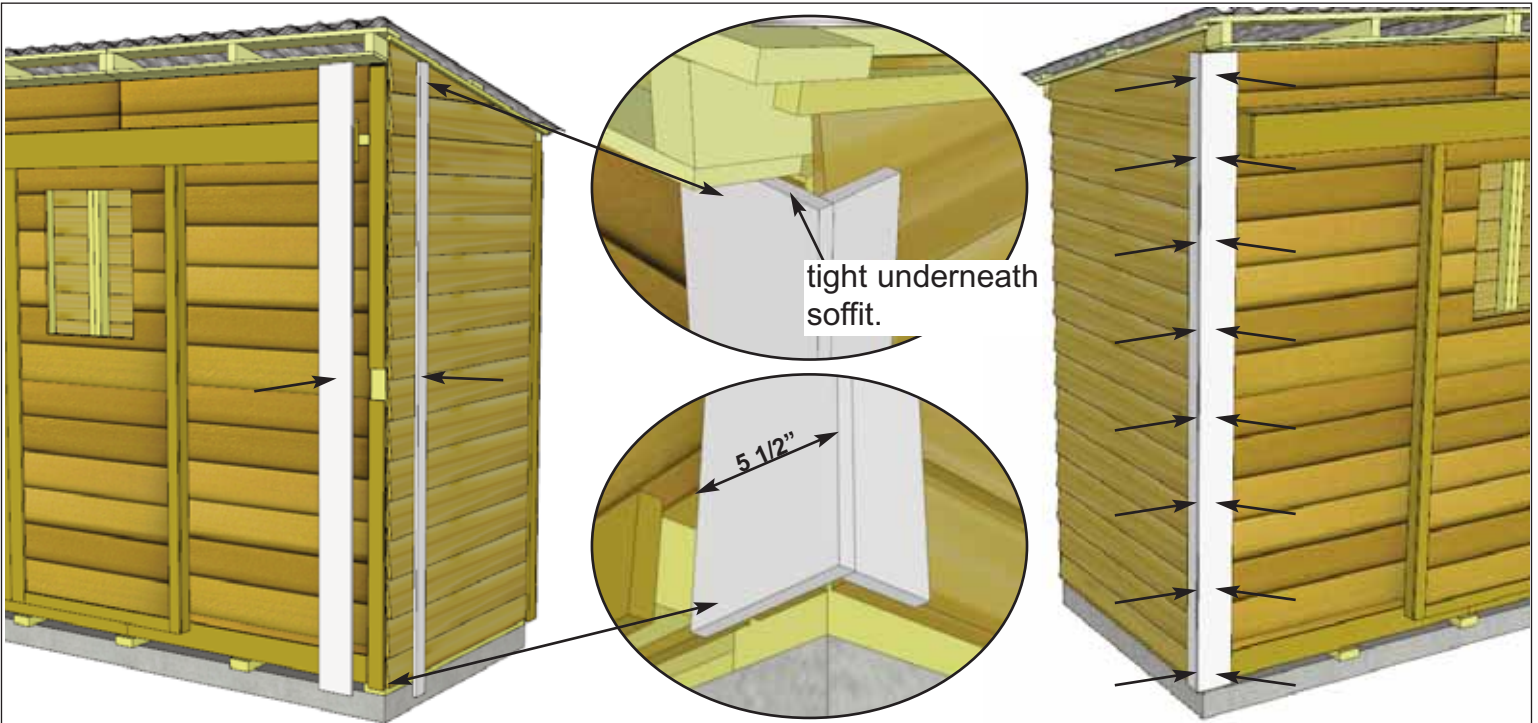

59. Place **4L & 4M - Front Corner Trims** in front corner and align as illustrated above. Do a dry run prior to attaching to achieve best fit. Start with 5 1/2" wide Front Corner Trim and align tight underneath soffit to determine vertical height. Attach with **8 - 1 1/2" Finishing Nails** per piece. Position and attach Side Front Corner Trim (2 1/2" wide) using **8 - 1 1/2" Finishing Nails**, aligning at bottom with wide trim.

<u>Parts</u>
4L - Front Corner Trims (1/2" x 5 1/2" x 88 3/4") x 2
4M - Side Front Corner Trims (1/2" x 2 1/2" x 88 3/4") x 2
<u>Hardware</u>
N1 - 1 1/2" Finishing Nails x 32 total

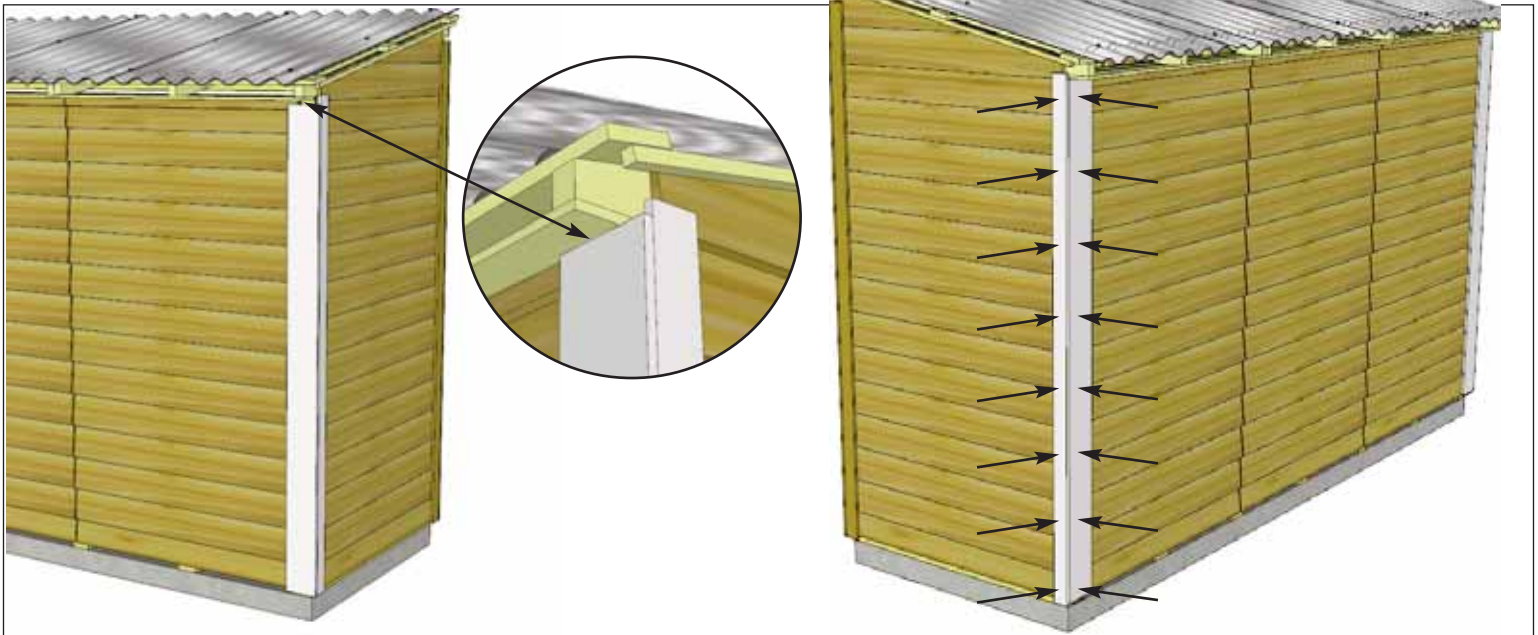

60. To complete trimming out rear corners, locate **4N & 4O - Rear Corner Trims**. Align and attach as per **Step 59**.

Parts
4N - Rear Corner Trims
 (1/2" x 5 1/2" x 78 1/2") x 2
4O - Side Rear Corner Trims
 (1/2" x 2 1/2" x 80") x 2

Hardware
N1 - 1 1/2" Finishing Nails
 x 32 total

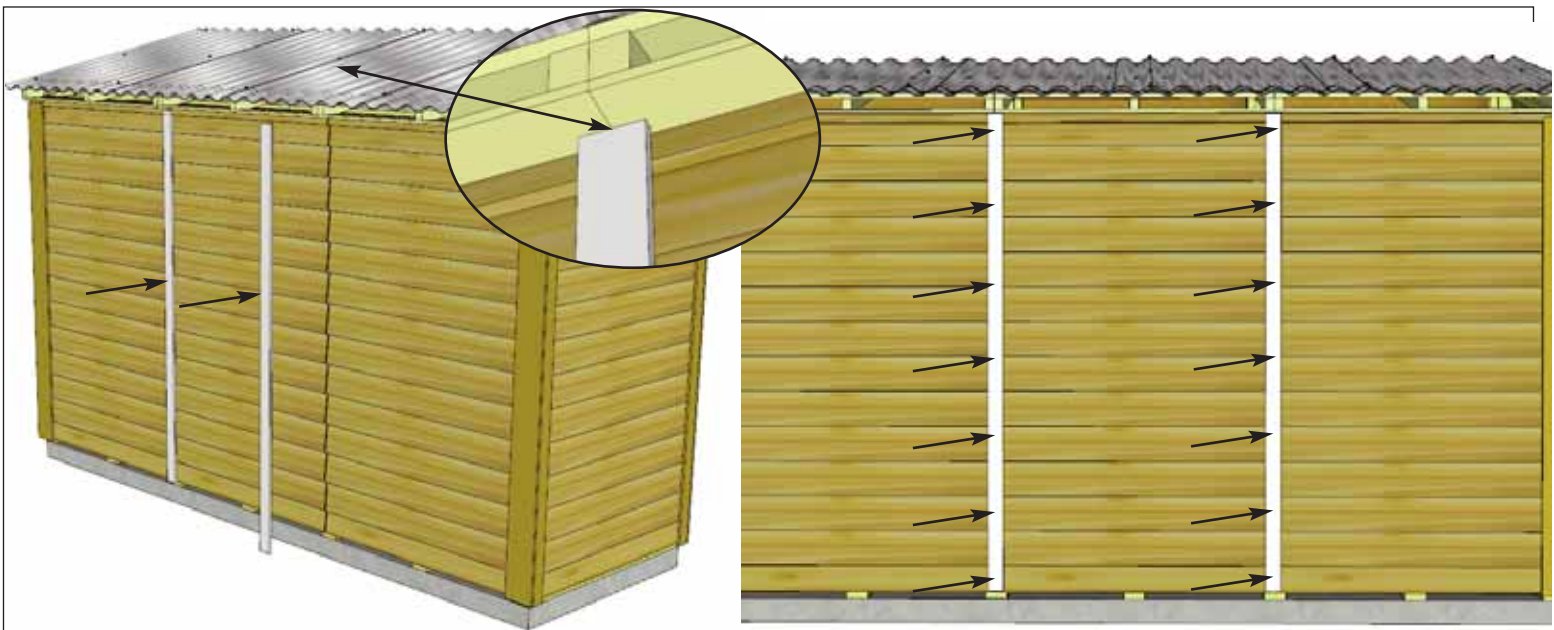

61. Attach **4P - Rear Middle Trims** where wall panels come together at rear seam. Attach with **8 - 1 1/2" Finishing Nails** aligning tight underneath soffit and center on seam.

Parts
4P - Rear Middle Trim
 (1/2" x 2 1/2" x 78 1/2") x 2

Hardware
N1 - 1 1/2" Finishing Nails
 x 16 total

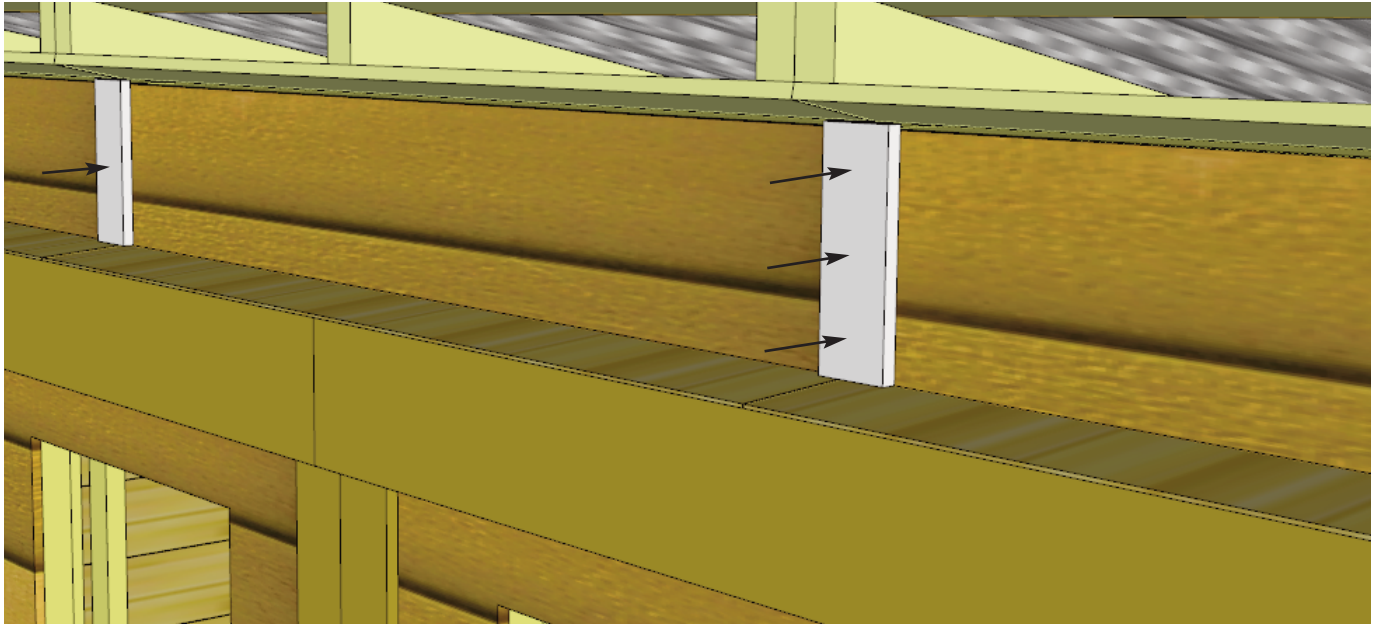

62. Attach **4Q - Front Middle Trims** above doors where front wall extenders come together above track. Attach with **3 - 1 1/2" Finishing Nails** per piece, aligning tight underneath soffit and centered on seam.

Parts	Hardware
4Q - Front Middle Trim (1/2" x 2 1/2" x 7 1/2") x 2	N1 - 1 1/2" Finishing Nails x 6 total

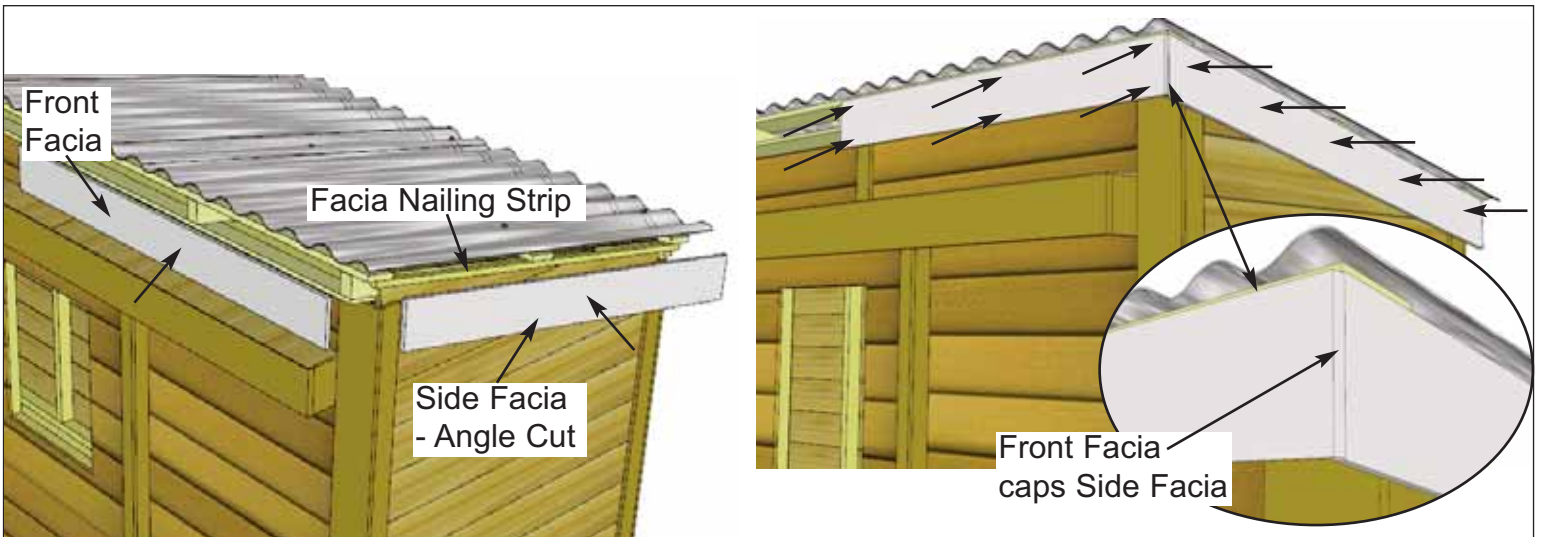

63. Locate one **4R - Side Facia** and one **4S - Front Facia** and align in front corner. Position facias underneath roof panel, doing a dry run first before securing. Front Facia goes against rafter ends and Side Facia goes against Facia Nailing Strip. Align so the Front Facia caps the Side Facia. Attach Front Facia with **2 - 1 1/2" Finishing Nails** per rafter end. Attach Side Facia to the Facia Nailing Strip with **5 - 1 1/2" Finishing Nails**.

Parts (Steps 63 - 66)	Hardware (Steps 63 - 66)
4R - Side Facia - Angle Cut Ends (1/2" x 5 1/2" x 54 1/8") x 2	N1 - 1 1/2" Finishing Nails x 46 total
4S - Front & Rear Facia - L/R (1/2" x 5 1/2" x 50 1/2") x 4	
4T - Front & Rear Facia - Center (1/2" x 5 1/2" x 45 1/2") x 2	

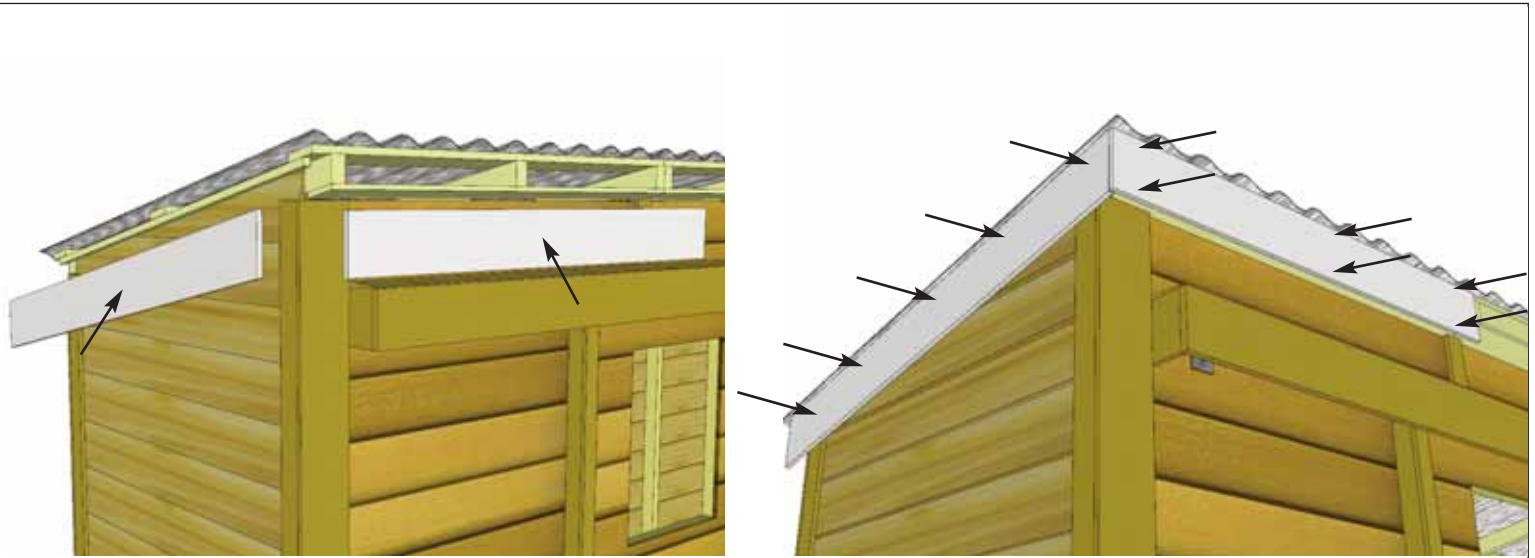

64. Attach other Front and Side Fascia to opposite corner as per **Step 63**.

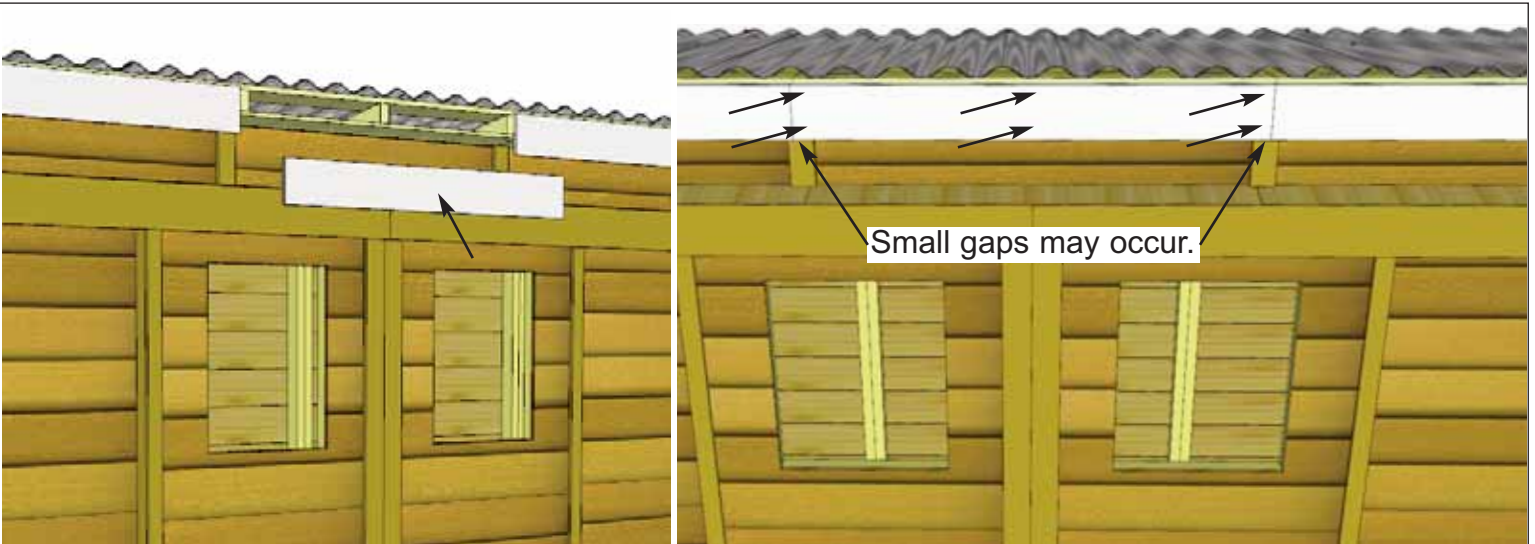

65. Attach **4T - Front Fascia - Center** to rafter ends as shown above. Small gaps may occur between the Center and Left/Right Fascia, but these will be covered by the Front Metal Drip Cap in **Step 68**. Attach with **2 - 1 1/2" Finishing Nails** per rafter end.

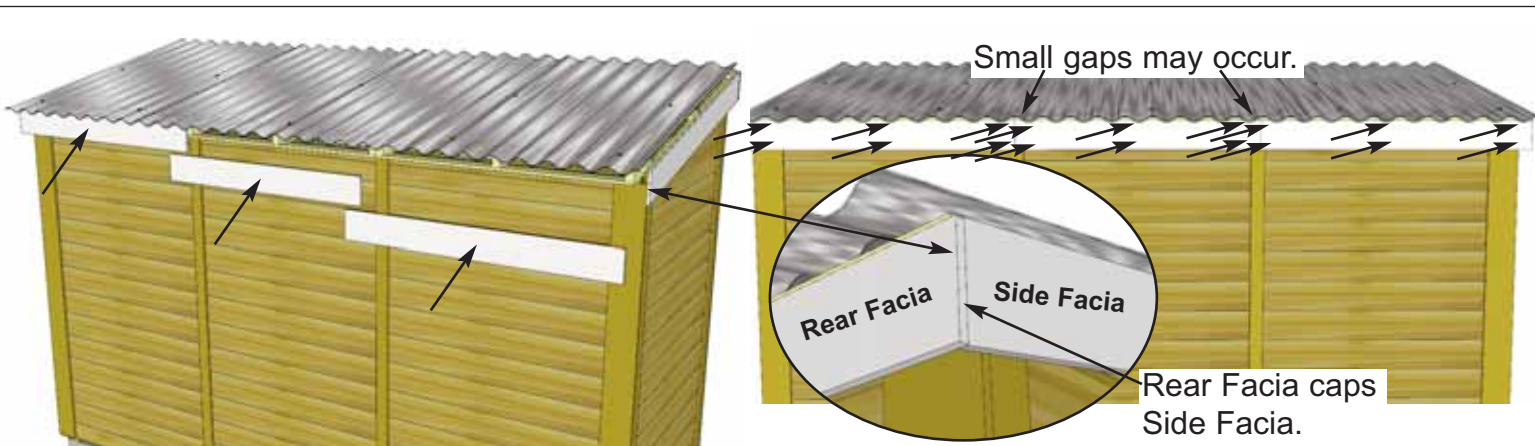

66. Attach **4S & 4T - Rear Fascia** onto rafter ends as per **Steps 63**. Small gaps may occur between the Center and Left/Right Fascia, these will be covered by Fascia Detail Plates in **Step 67**. Rear Fascia will cap the side Fascia. Attach Rear Fascia to rafter ends with **2 - 1 1/2" Finishing Nails** per rafter end.

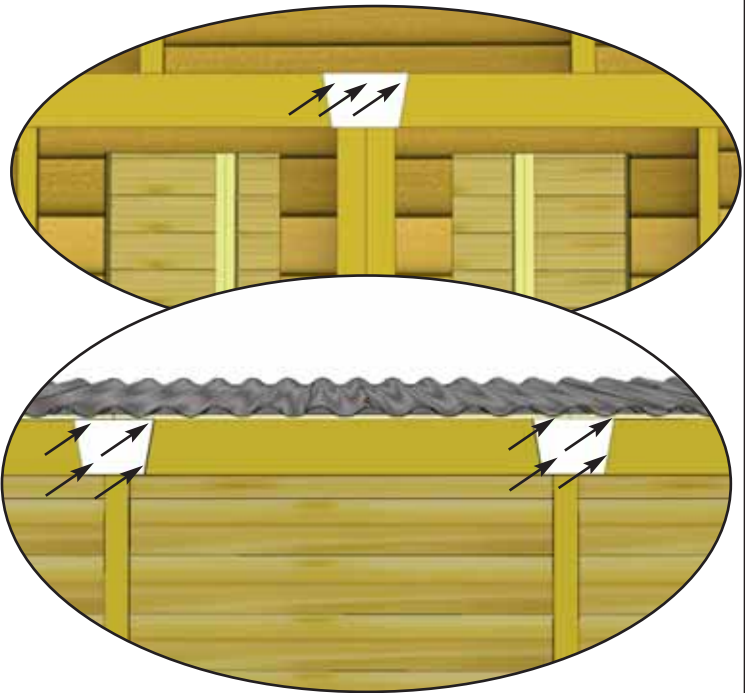
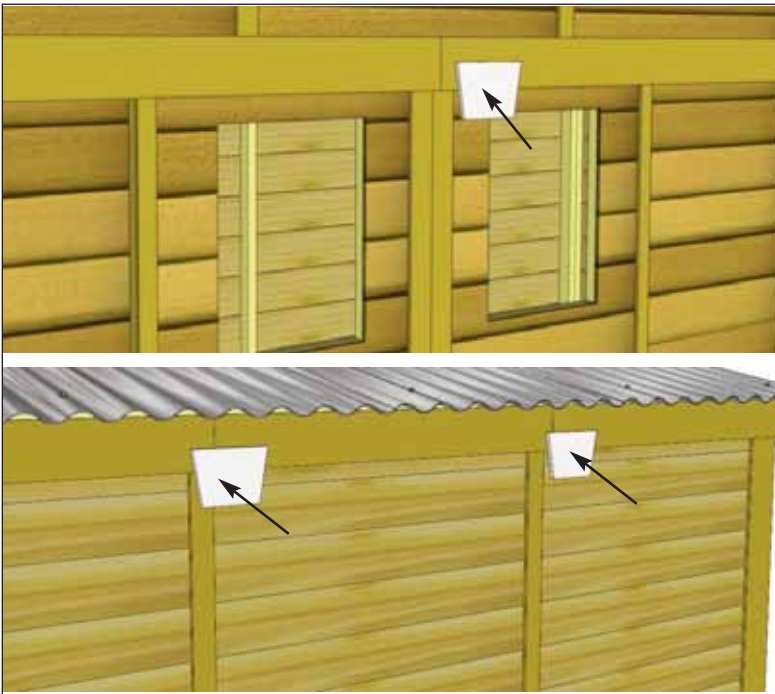

67. Attach **4U - Trim Detail Plates** to cover seams. Two Plates will cover seams where Rear Facia pieces meet, attach these with **4 - 1 1/2" Finishing Nails** per piece. One more Trim Plate will cover the seam of the Track Overlay, attach with **3 - 1 1/2" Finishing Nails** along the top of the Plate so nails are secured to 2x4 backing.

<u>Parts</u>
4U - Trim Detail Plates (5 1/2" high) x 3
<u>Hardware</u>
N1 - 1 1/2" Finishing Nails x 11 total

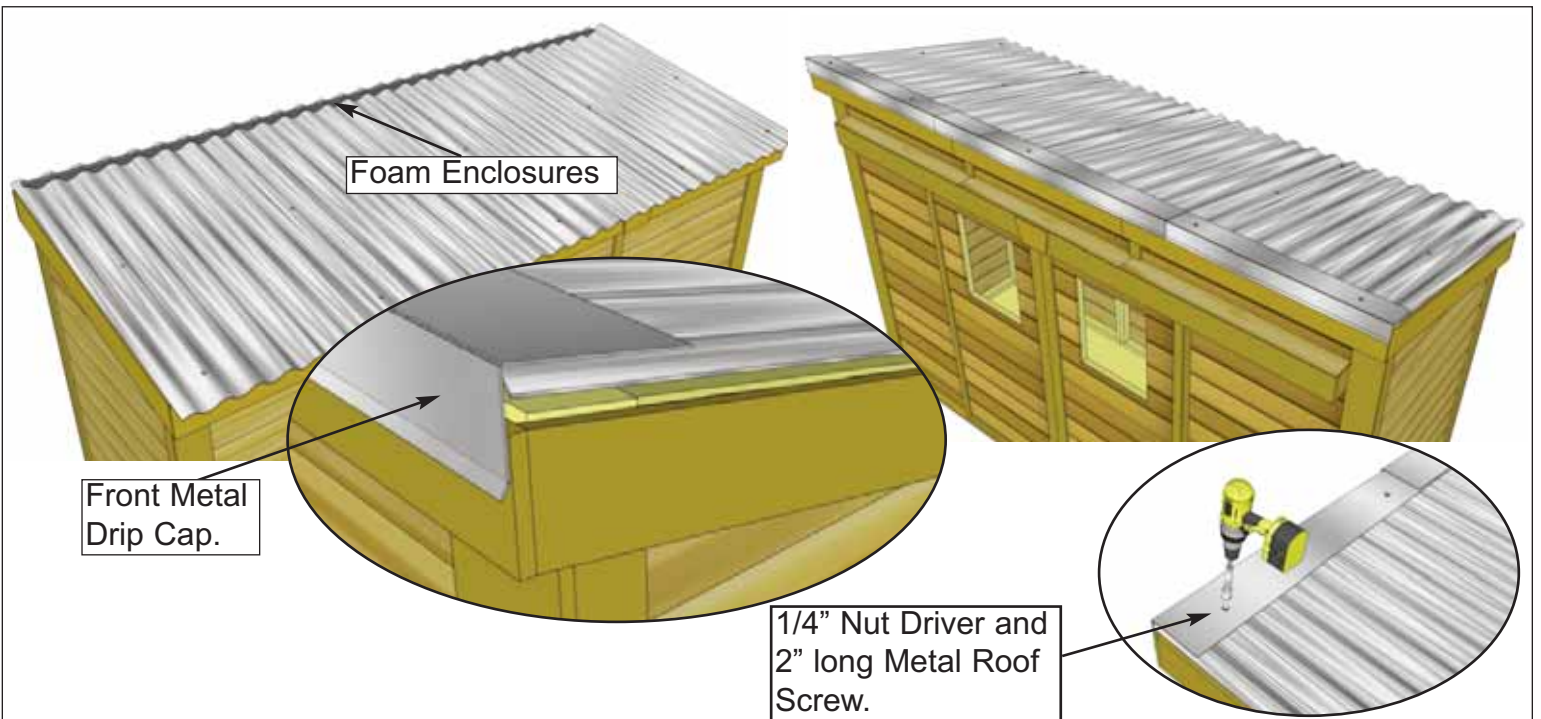

68. Place **Foam Enclosures** at top of Metal Roof. Place **Front Metal Drip Caps (3 pieces - 60" long)** on top of metal roof at front. Evenly space from side-to-side allowing caps to overlap each other. Overhang the cap approximately 1" past each end. When Drip Cap is correctly positioned, secure with **5 - 2" long self tapping Metal Roof Screws** as per **Step 44**. Screw into to top batten. Do not overtighten.

<u>Parts</u>
4V - Front Metal Drip Caps (6" x 60" -angled) x 3
Foam Enclosures (Several)
<u>Hardware</u>
2" Metal Roof Screws x 5 total

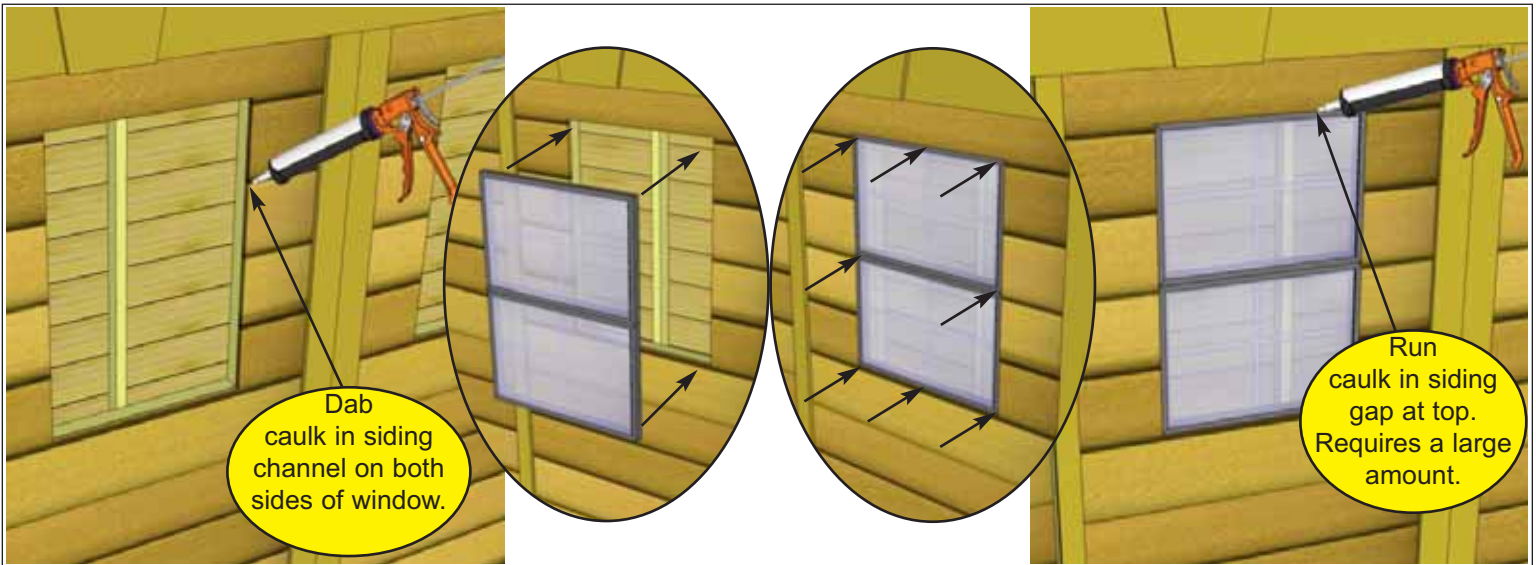

69. Locate **4W - Window Inserts**. Before installing, dab caulk in siding channel on both sides of window opening. This will prevent water from getting in behind window. Position window in cavity and secure with **8 - 1 1/4" Screws**. Caulk gap between siding and window at top. This requires a large amount of caulking but is important to fill. Later, Window Trims will be installed to hide caulking. Complete second Window Insert the same.

<u>Parts</u>
4W - Window Inserts (18 1/4" x 23") x 2
<u>Hardware</u>
S2 - 1 1/4" Screws x 16 total

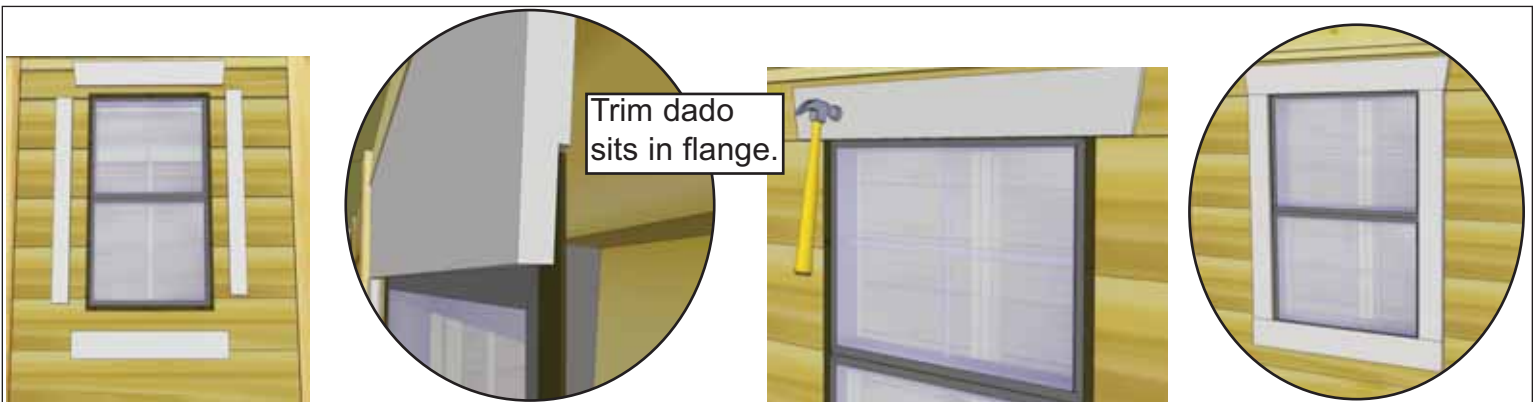

70. Position **4X - Window Trim** around window doing a dry run first and attach with **4 - 1 1/2" Finishing Nails** per piece. Window trim has a small dado on reverse face. Outside flange of window will roughly sit in the dado to give a better fit. Complete both windows the same.

<u>Parts</u>
4X - Window Trim Kit x 2 (Top pc - 24 1/16") x 1- Angle Ends (Side/Bottom pcs - 23") x 3
<u>Hardware</u>
N1 - 1 1/2" Finishing Nails x 32 total

71. Attach **Y3 - Door Handles** and **Y11 - Black Hasp**. Handles and Hasp are positioned on wide door trim and mounted with **3/4" Black Screws**.

<u>Hardware</u>
Y3 - Door Handles x 2 total
Y11 - Black Hasp x 1 total
SB1 - 3/4" Screws x 16 total

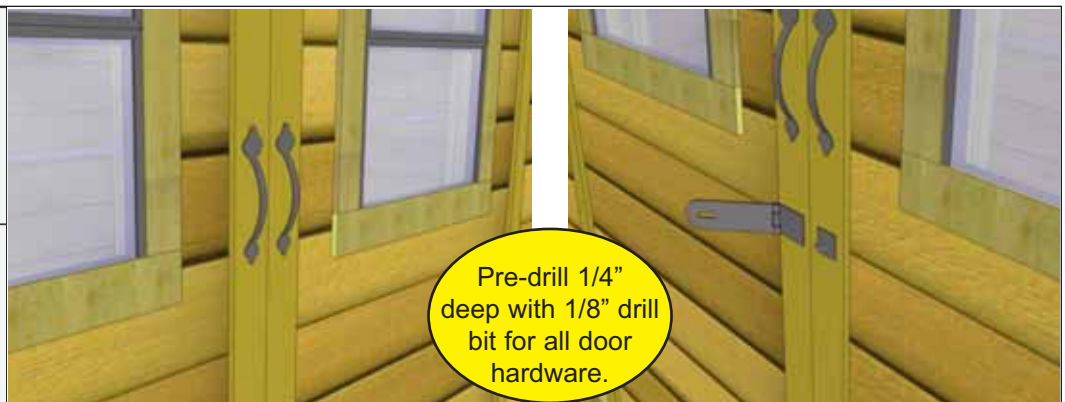



Congratulations on assembling your 12x4 GardenSaver Shed with Sliding Double Doors!

Note: Our Sheds are shipped as unfinished products. If exposed to the elements, the western red cedar lumber will weather to a silvery-gray color. If you prefer to keep the cedar lumber looking closer to the original color, we suggest that you treat the wood with a good oil base wood stain. You may also wish to paint your new shed rather than stain it. In both cases we recommend that you consult with a paint and stain dealer in your area for their recommendations.

We hope your experience assembling your 12x4 Slider Lean-To Storage Shed has been both positive and rewarding.

We value your feedback and would like to hear back from you on how well we are doing in the following areas:

1. Customer Service
2. On Time Shipping
3. Motor Freight Delivery
4. Quality of Materials
5. Assembly Manual
6. Overall Satisfaction.



Please call, write or email us at:

Outdoor Living Today

Canadian Address
9393 287th Street
Maple Ridge, British Columbia
Canada V2W 1L1

United States Address
P.O. Box 96
Sumas, Washington
USA 98295



The materials contained in this Assembly Manual may be downloaded or copied provided that ALL copies retain the copyright and any other proprietary notices contained on the materials. No material may be modified, edited or taken out of context such that its use creates a false or misleading statement or impression as to the positions, statements or actions.